



nickelodeon
TEENAGE MUTANT NINJA
TURTLES™

79105





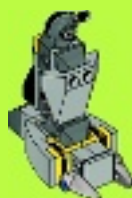
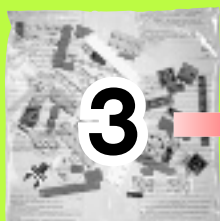
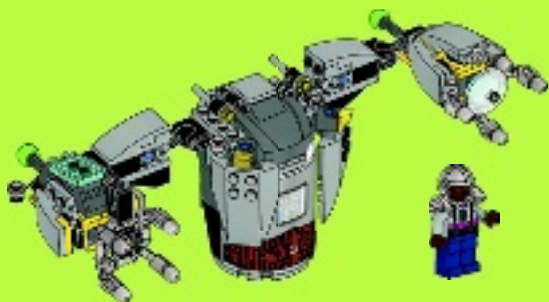

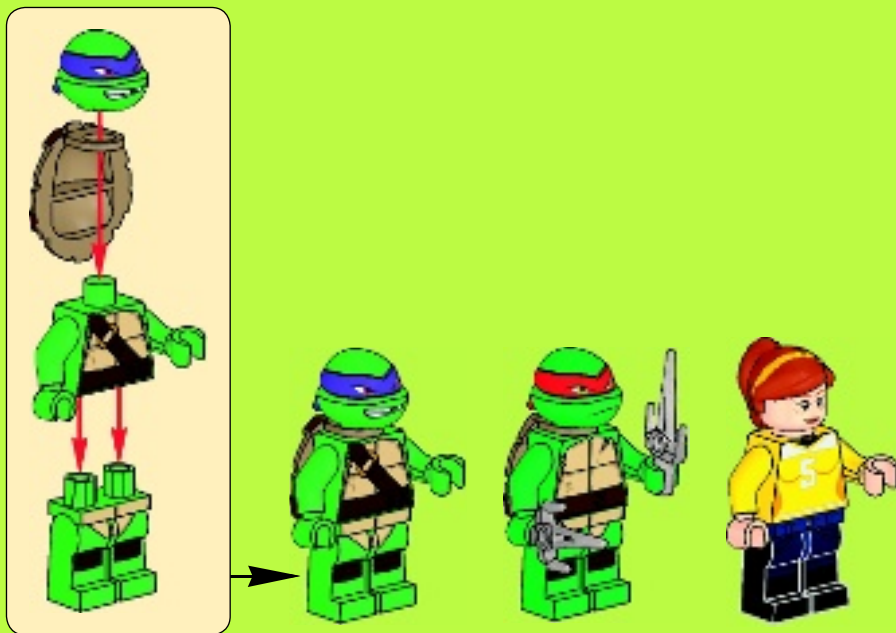



1x



1x

1



1x



1x

2



1x

3





1x

4



5



2x



2x

6

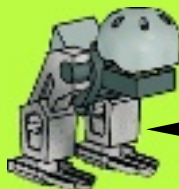

2x



1x

1



2x



2x

2





1x

3



1x



1x



1x



1x

4

1



2



3



4

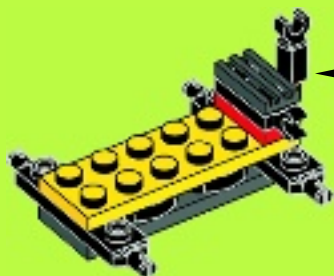



1x



1x



1x

5

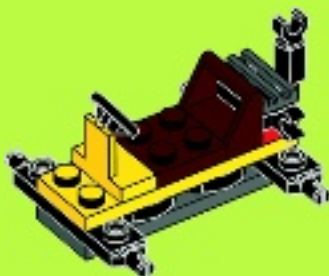

2x



4x



1x

6

1

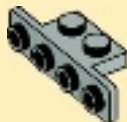

2



3



4

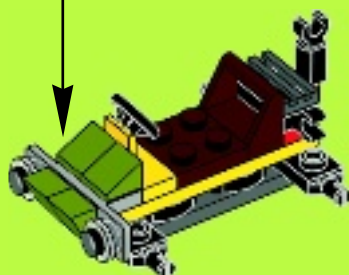
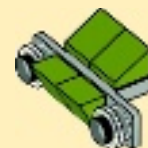



1x



1x



1x

7

1

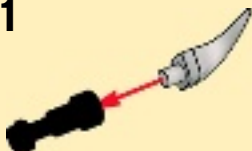

2





8

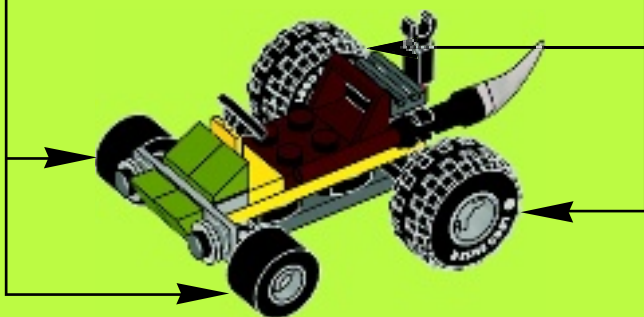
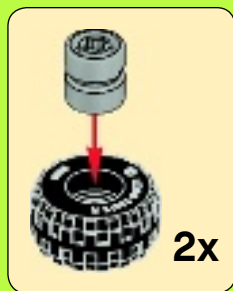
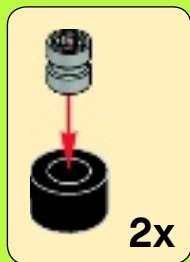



2x



1x

9

1

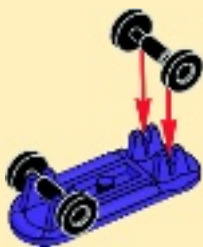

2

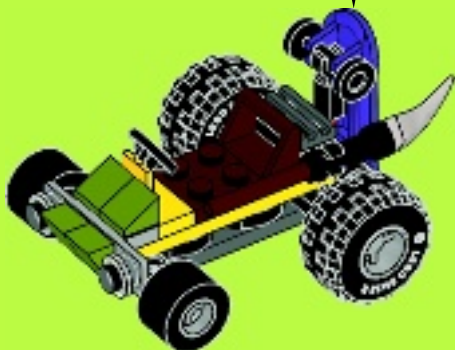

10

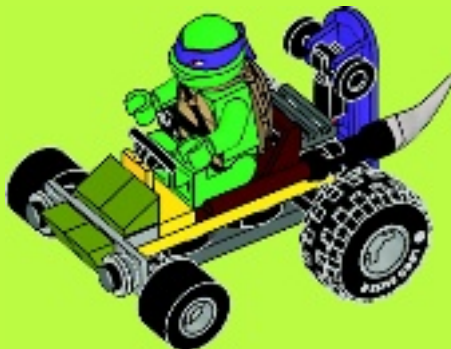

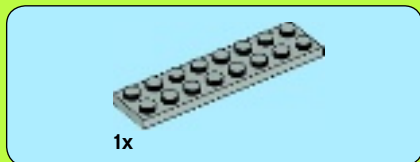

1

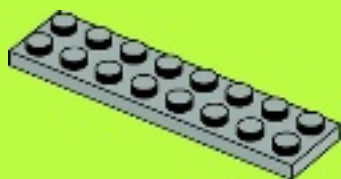

2

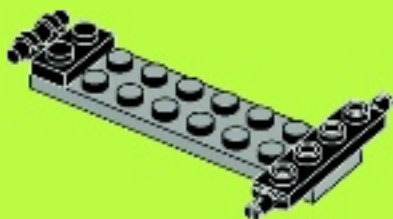



6x

3

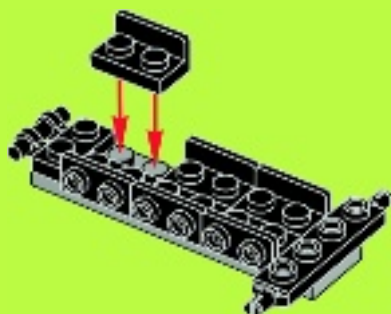

1x



1x



1x

4

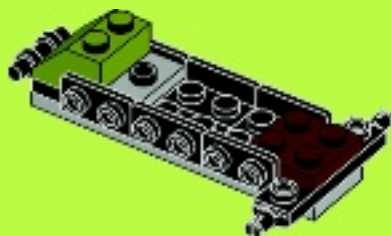



1x



1x



1x

5



1x



1x



1x



1x

6

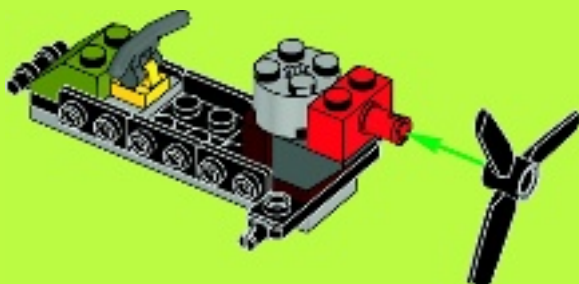

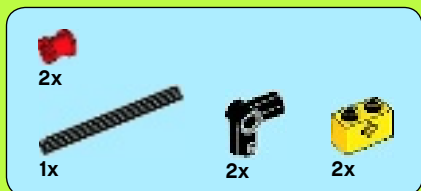

7

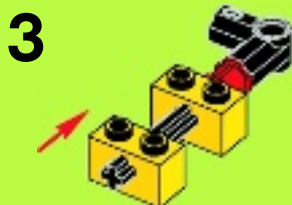

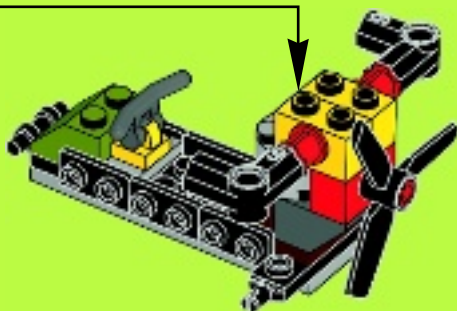

2x



2x



2x

8

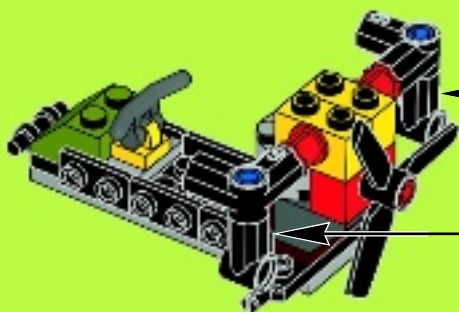



1x

9

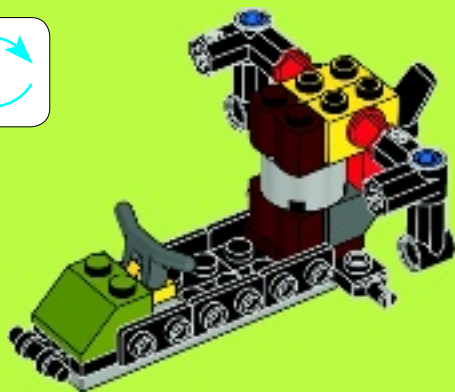

1x



1x

10

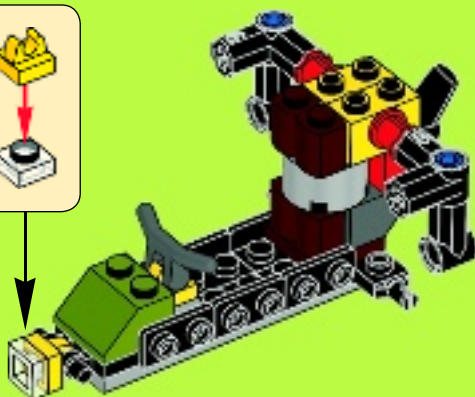
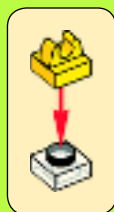



1x



1x

11

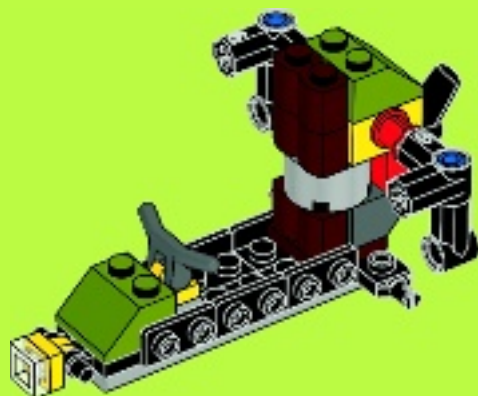

2x



1x

12

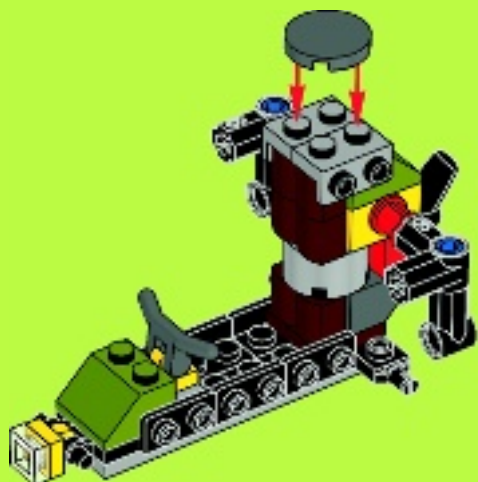



2x



2x

13

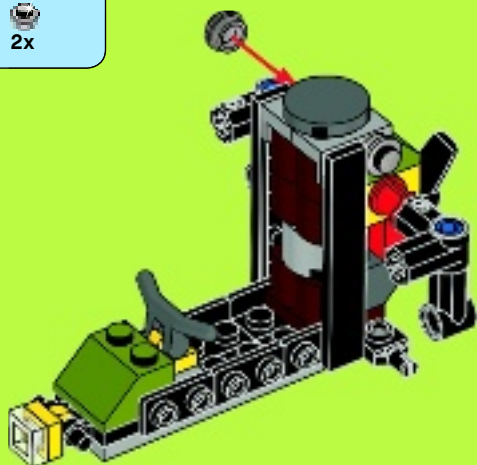

2x



2x

14

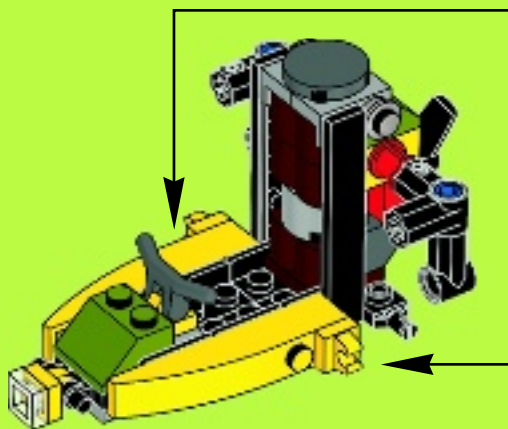
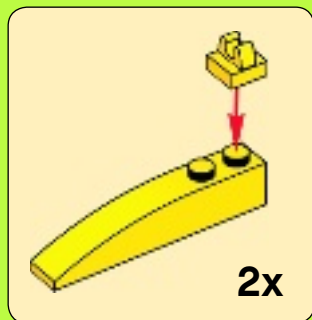



15

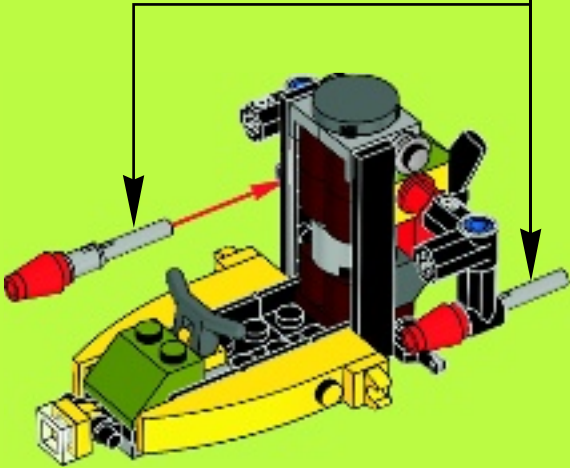
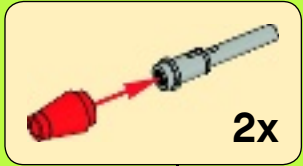



4x



2x



2x

16

1

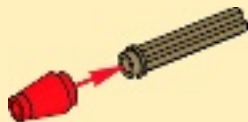

2

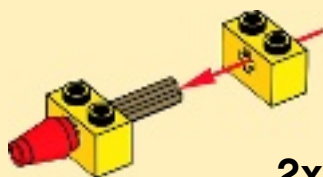

2x

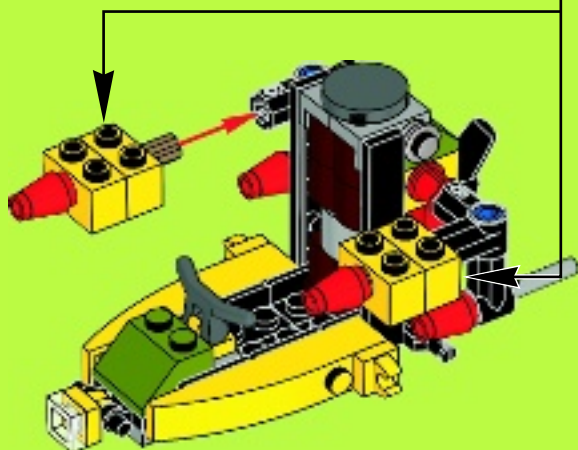



1x



1x

17

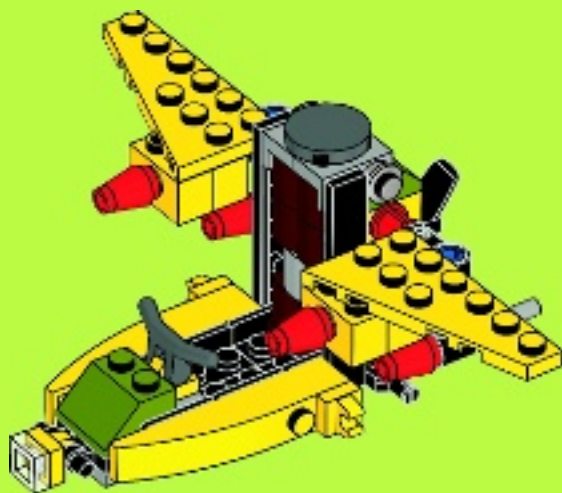



18

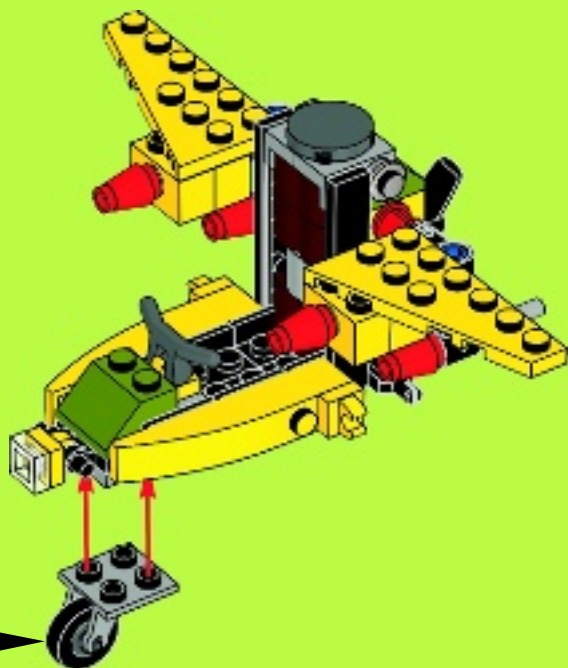
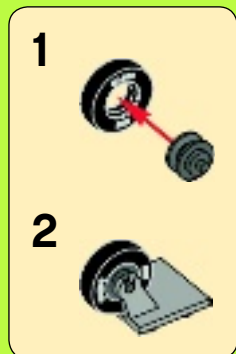



2x



2x

19

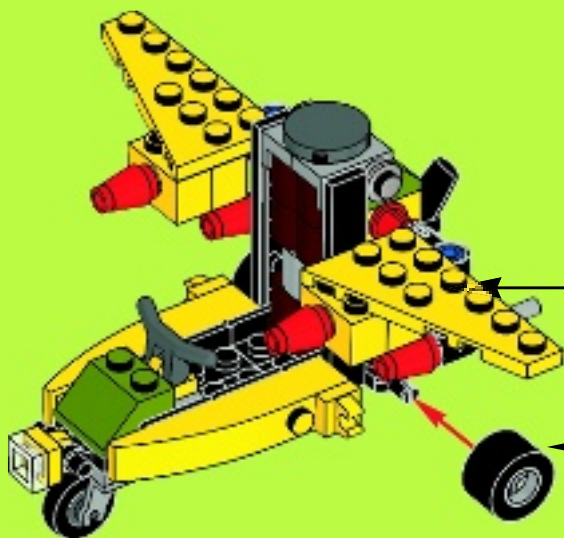

2x

20

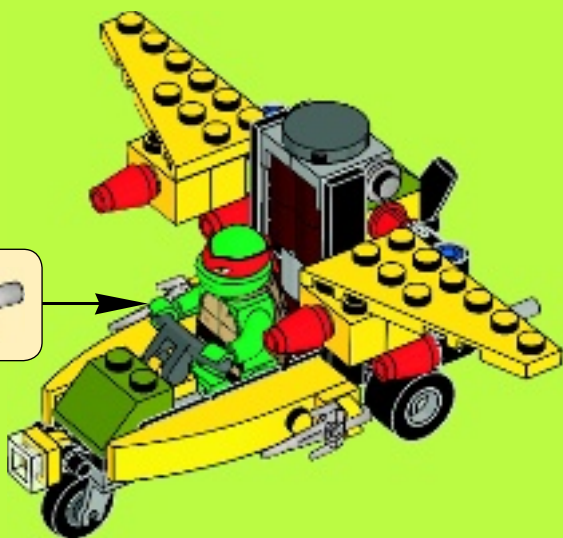

4x
6030719



12x
4615642



2x
244424



15x
302324



1x
6024659



1x
9553



6x
4233484



2x
4160392



3x
302124



4x
379524



1x
4527076



1x
4527080



1x
4666999



1x
6028416



1x
6028416



1x
245821



1x
623221



4x
4529234



1x
654121



1x
241221



1x
4611701



2x
74335



2x
4186678



1x
4254606



2x
4227155



12x
4206482



2x
4514553



1x
6030185



1x
6025395



1x
6030247



1x
6028416



1x
4162916



1x
6023044



1x
6025366



1x
6024629



1x
6023051



1x
6030792



1x
6023060



1x
6023062



10x
6008483



8x
6030198



2x
4636105



2x
4646867



1x
4646815



1x
4617190



4x
4612765



1x
4166093



9x
4211180



3x
4613975



1x
4211219



1x
6024664



1x
6030330



1x
3000840



2x
3005740



1x
4186513



1x
6003198



1x
6032248



1x
4603191



1x
3006843



2x
4260942



3x
3005744



1x
4166093



2x
4624381



3x
6031821



4x
6002841



2x
6016474



1x
6022953



1x
4538950



1x
6020990



9x
4633691



2x
6030333



1x
6030184



1x
4521921



3x
4558953



1x
4211451



2x
4654582



3x
4211632



1x
4211580



3x
4211413



2x
4654577



4x
4654580



2x
4515369



5x
4278273



1x
4211526



3x
4211387



1x
4217918



1x
6014615



3x
4507056



11x
4211395



11x
4622742



1x
4618874



2x
6030235





1x
4515351



4x
6030574



1x
6015349



1x
4211406



1x
4211442



1x
6030872



1x
4198316



4x
6011375



2x
4211764



1x
4211351



5x
4520320



1x
4579354



1x
4620079



1x
4210631



2x
4210639



1x
4521512



1x
6005463



1x
4261908



2x
4210658



2x
4211039



1x
6006141



2x
4211096



3x
4567887



3x
4211111



5x
4218696



4x
4211000



2x
4497253



2x
4227395



6x
4220193



1x
4140588



2x
4210978



1x
4211053



2x
4508553



1x
4652464



1x
4243831



1x
4211002

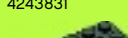

1x
4210917

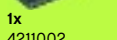

2x
4121715



1x
6015891

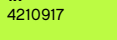

2x
249626

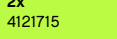

1x
4516843



4x
4508215



3x
306926



6x
6020193



1x
4619763



4x
4535739



2x
4107085



2x
4562148



16x
403226



2x
4213374



4x
4121966



2x
4107767



2x
4498340



2x
371026



4x
4560108



6x
374726



6x
4619763



2x
4636202



1x
4599984



3x
292626

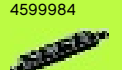

1x
4299388



1x
370626



2x
663626



1x
4275826

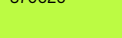

1x
4528332



Customer Service
Kundenservice
Service Consommateurs
Servicio Al Consumidor

LEGO.com/service or dial



: 00800 5346 5555

: 1-800-422-5346



WIN!

Go to www.LEGOsurvey.com/product to fill out a survey for a chance to win a cool LEGO® Product.

No purchase necessary.

Open to all residents where not prohibited.



LEGO.com



www.LEGOsurvey.com/product

GEWINNE!

Nimm an der Umfrage auf www.LEGOsurvey.com/product teil und hab die Chance ein cooles LEGO® Produkt zu gewinnen!

Die Teilnahme am Gewinnspiel führt zu keinerlei Kaufverpflichtungen. Teilnahme in allen nicht ausgeschlossenen Ländern möglich.

WIN!

Ga naar www.LEGOsurvey.com/product, vul een enquêteformulier in en maak kans op een cool LEGO® product.

Geen aankoopverplichting. Iedereen mag deelnemen, uitgezonderd ingezetenden van landen waar een enquêteverbod geldt.

GAGNE!

Visite www.LEGOsurvey.com/product pour répondre à un questionnaire et avoir une chance de gagner un produit LEGO® très cool!

Aucune obligation d'achat. Ouvert à tous les résidents des pays autorisés.

当てよう!

www.LEGOsurvey.com/product にアクセスして、アンケートにご記入ください。当選者にはレゴ®製品を差し上げます。

お買い上げの必要はありません。禁止されていない限り、すべての皆様にご利用いただけます。

LEGO and the LEGO logo are trademarks of the LEGO Group. ©2013 The LEGO Group.

6042815 ©2013 Viacom Overseas Holdings C.V. All Rights Reserved. Teenage Mutant Ninja Turtles and all related titles, logos and characters are trademarks of Viacom Overseas Holdings C.V.