

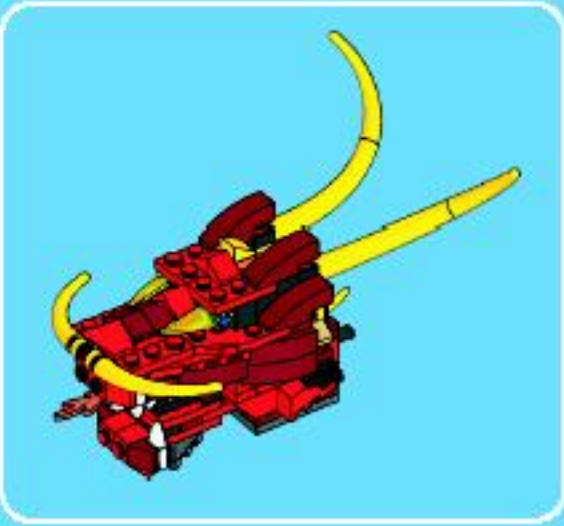

CREATOR

6751

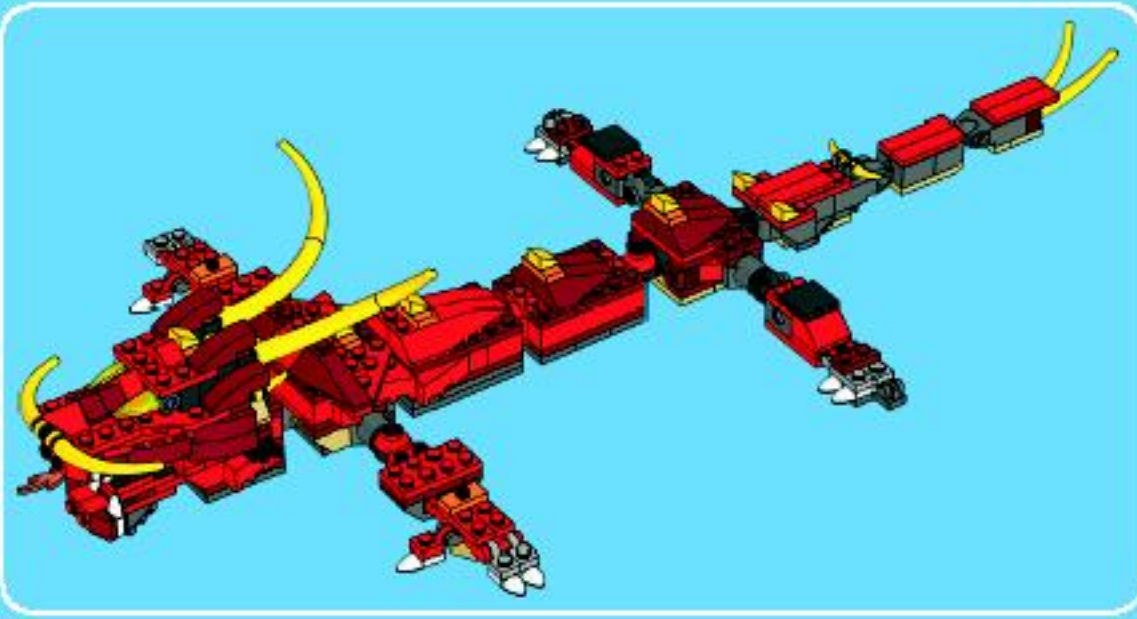



1



2



2

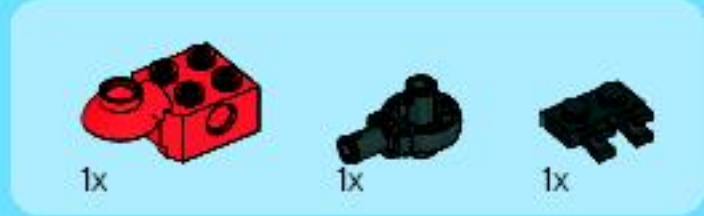

3

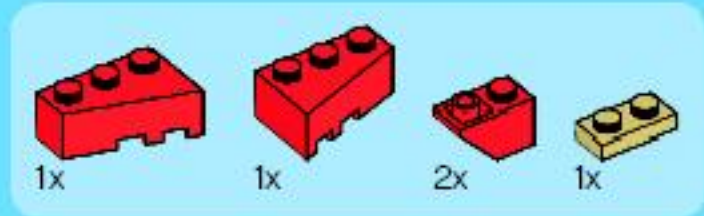
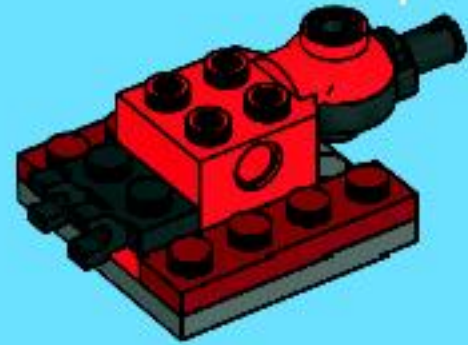

4

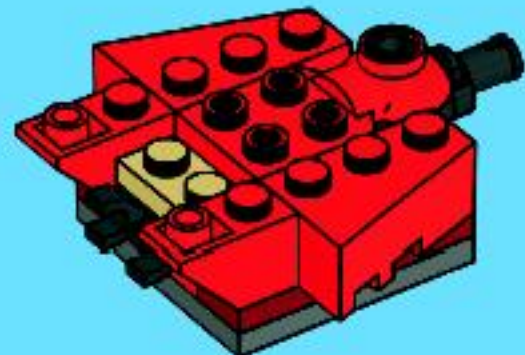

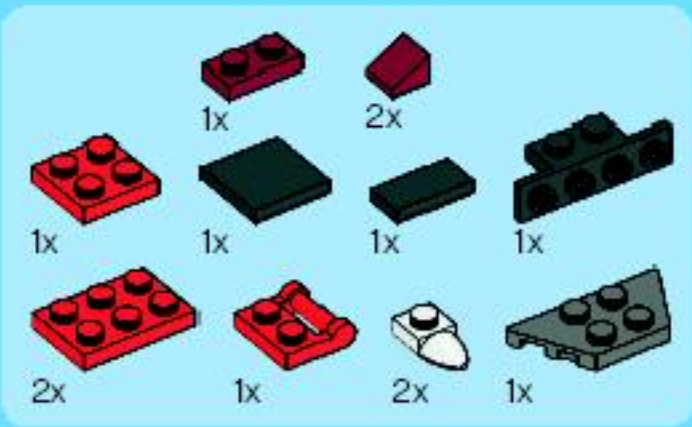

5

1



2



3



4



5

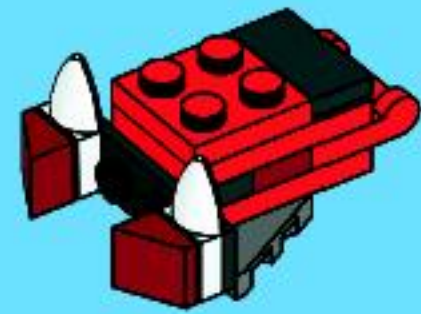

6

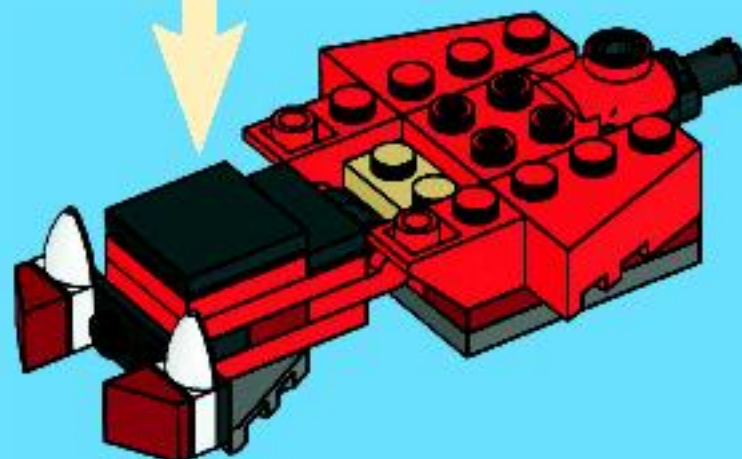



2x



1x



2x

6

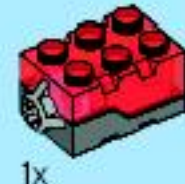
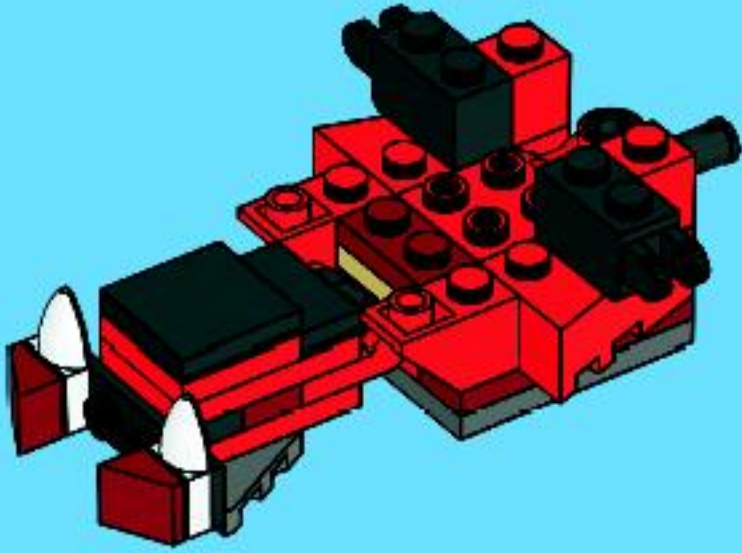

1x



2x



2x



8

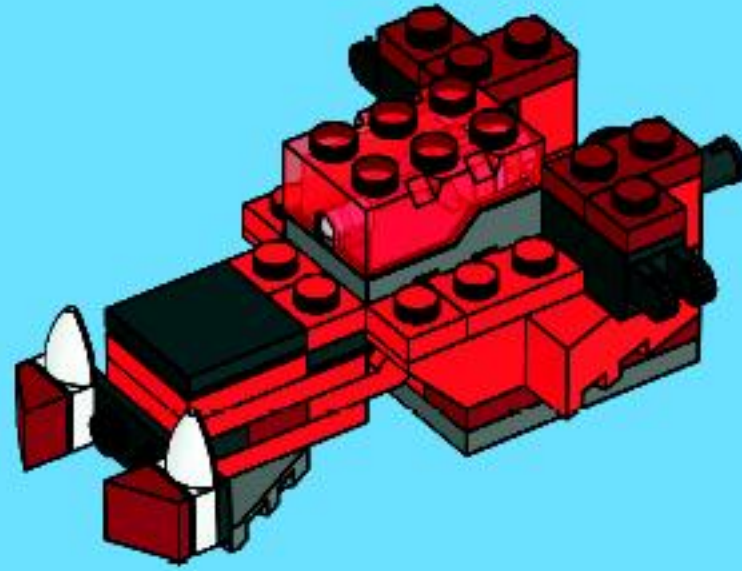

1x



2x

7

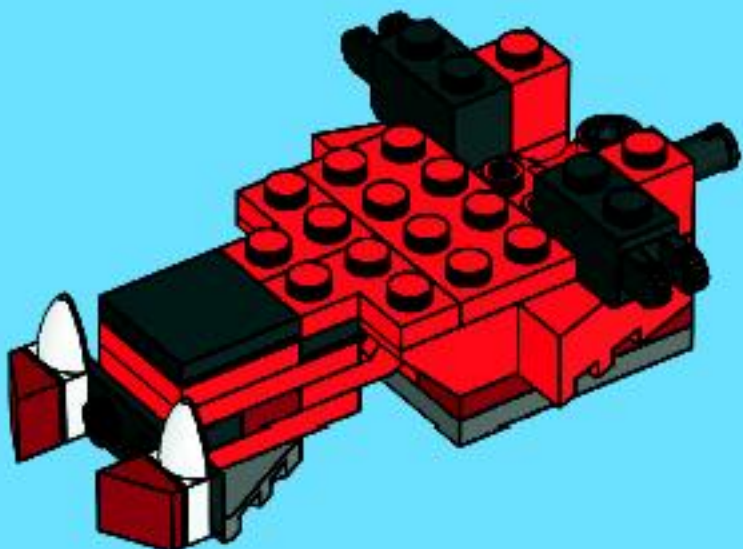

2x



1x

9

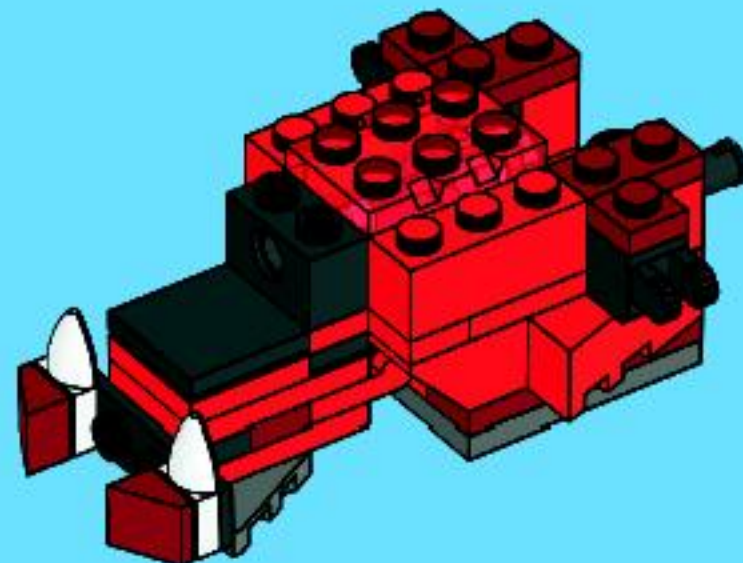



10

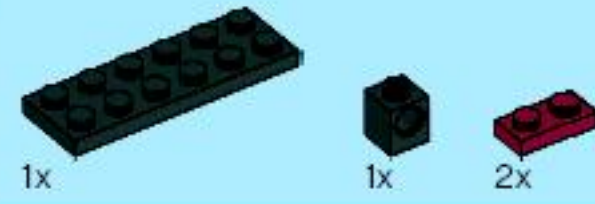
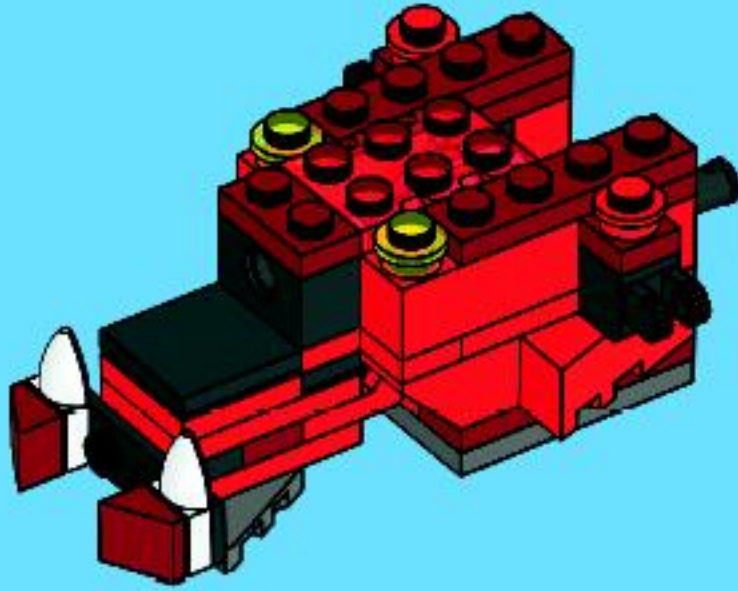

12

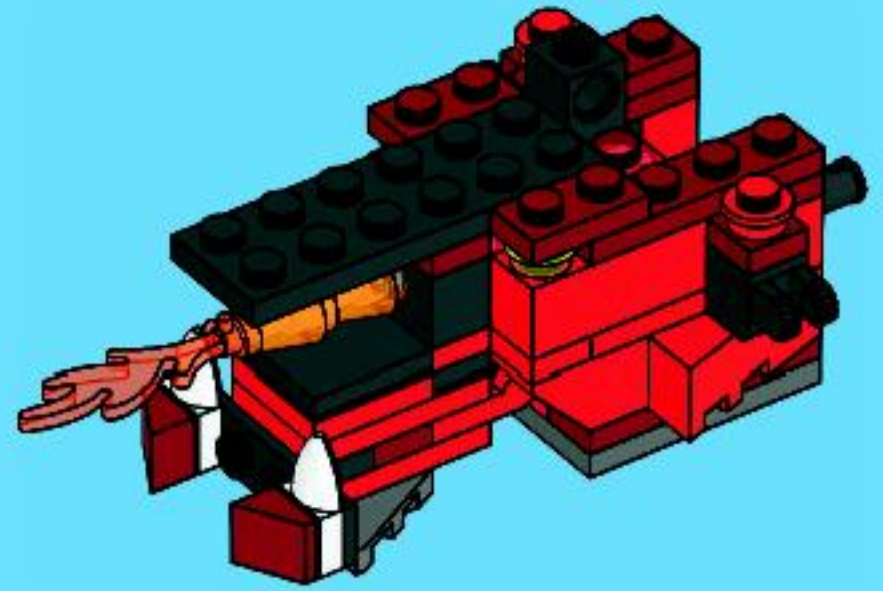

11

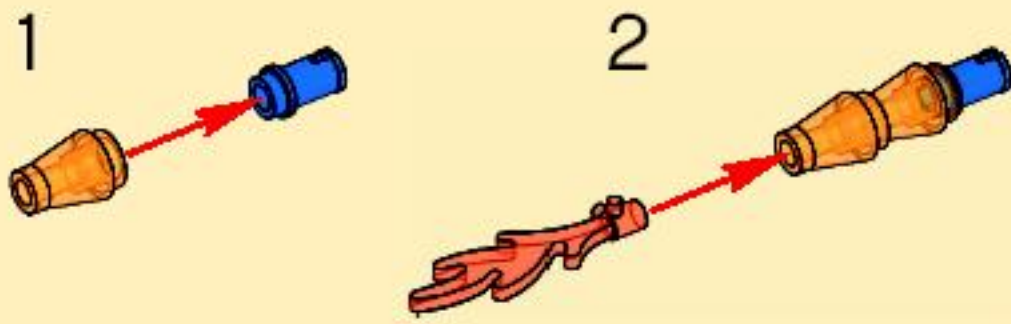

13

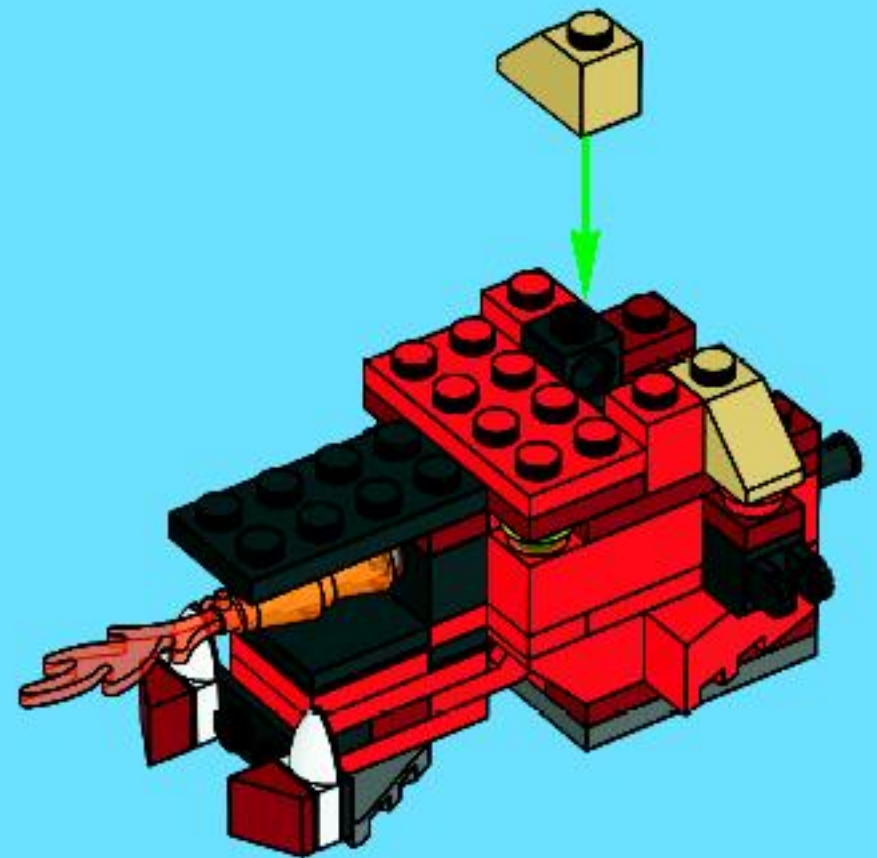

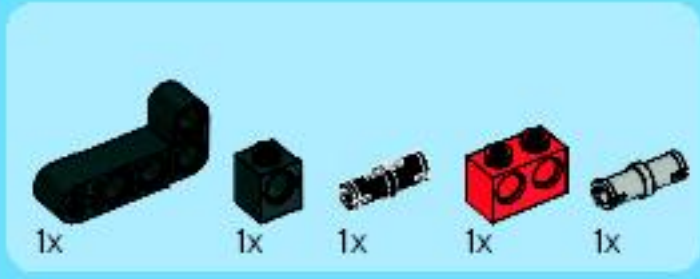

14

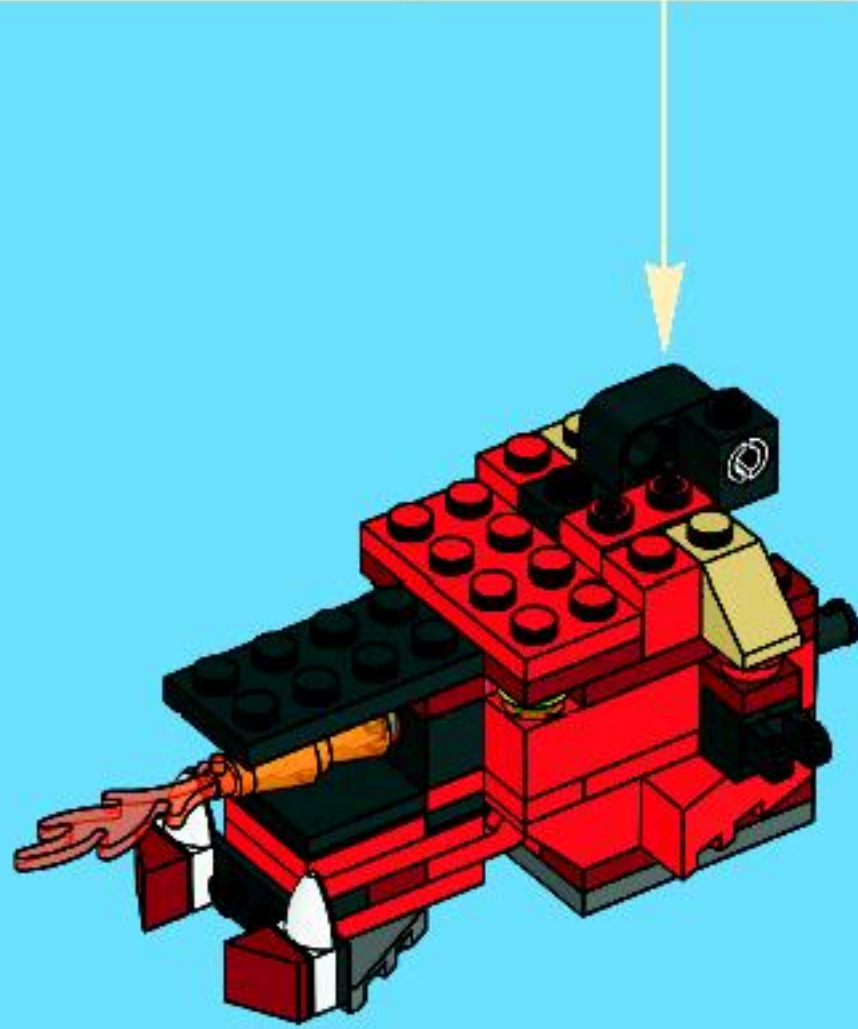
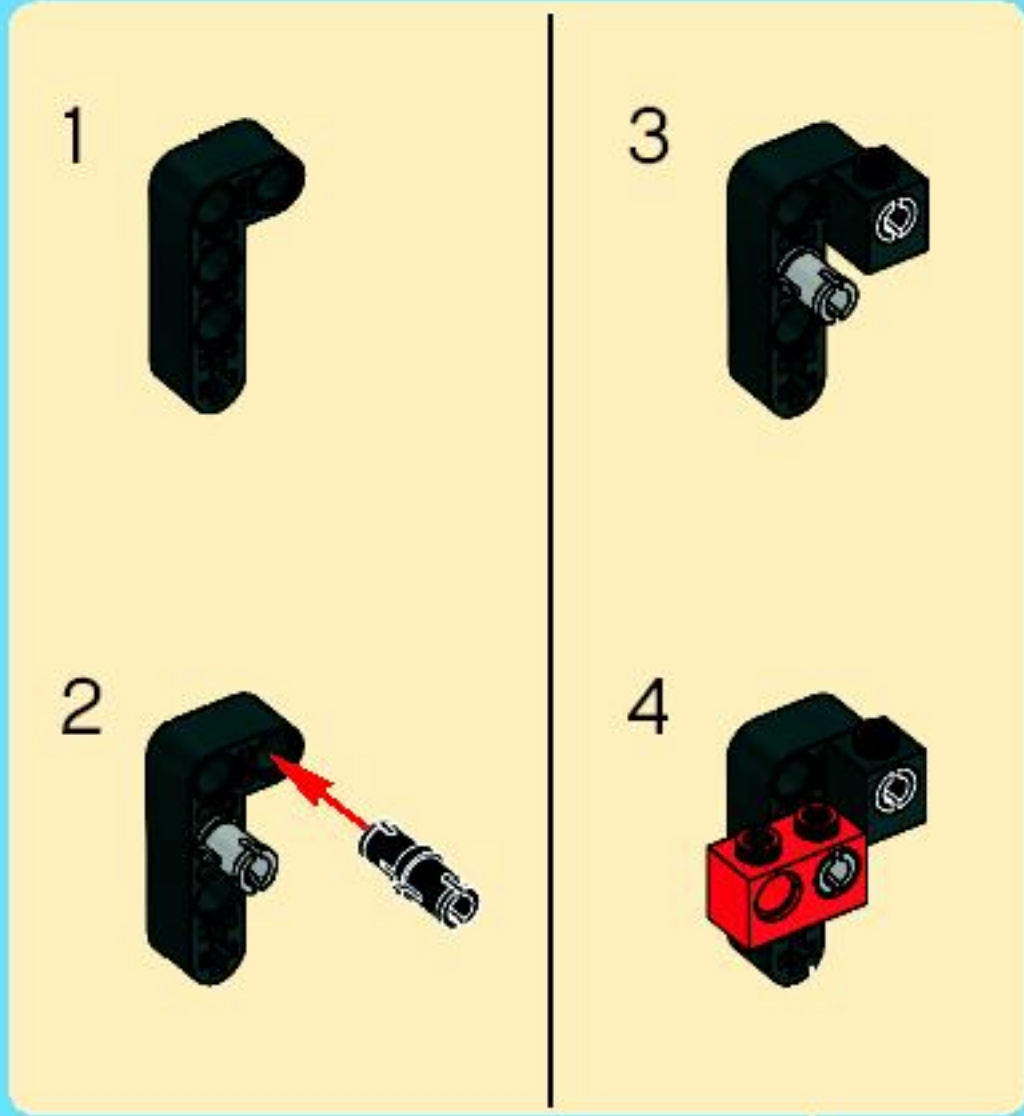

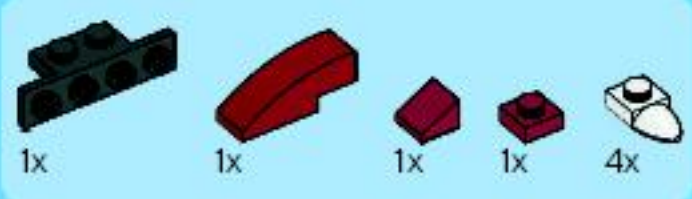

15

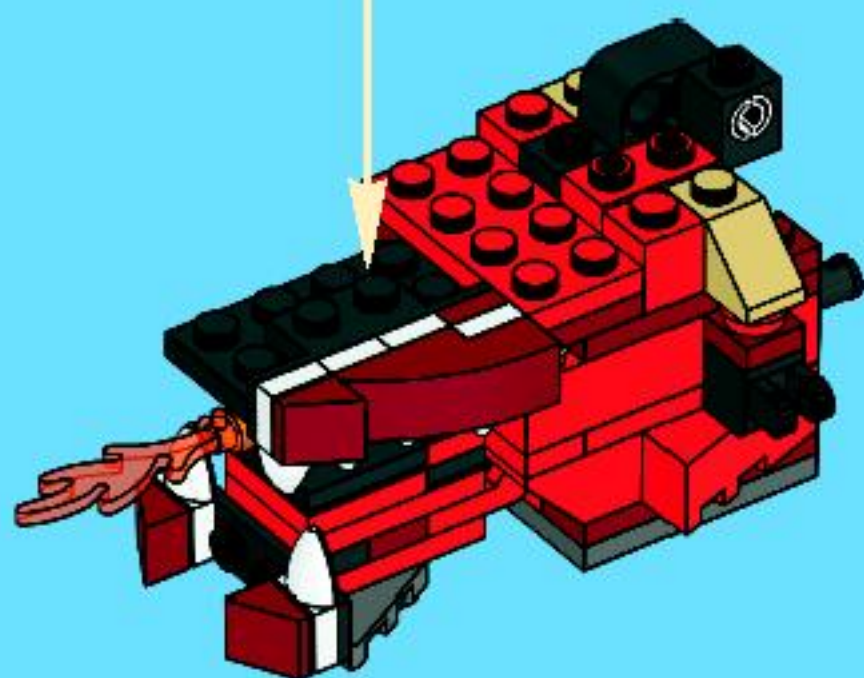
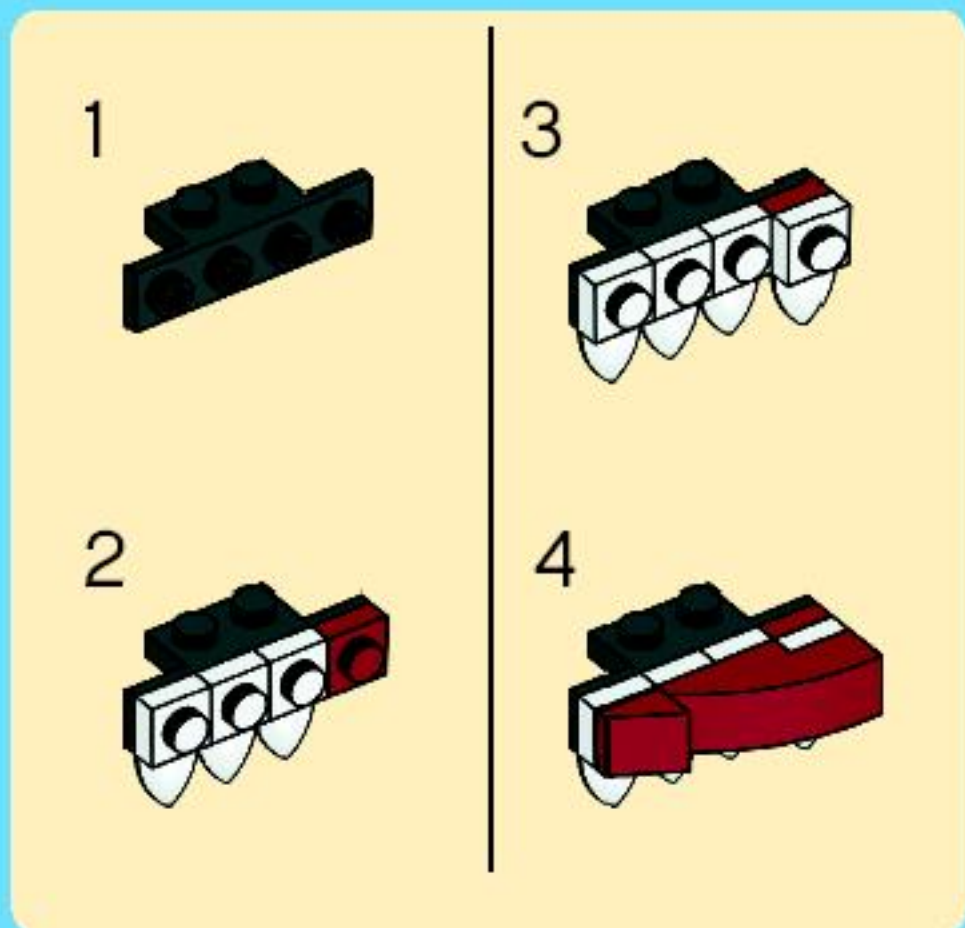

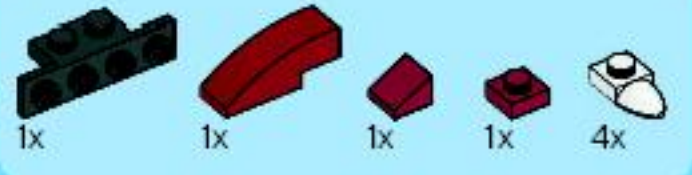

16

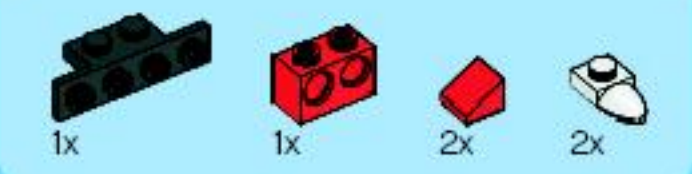
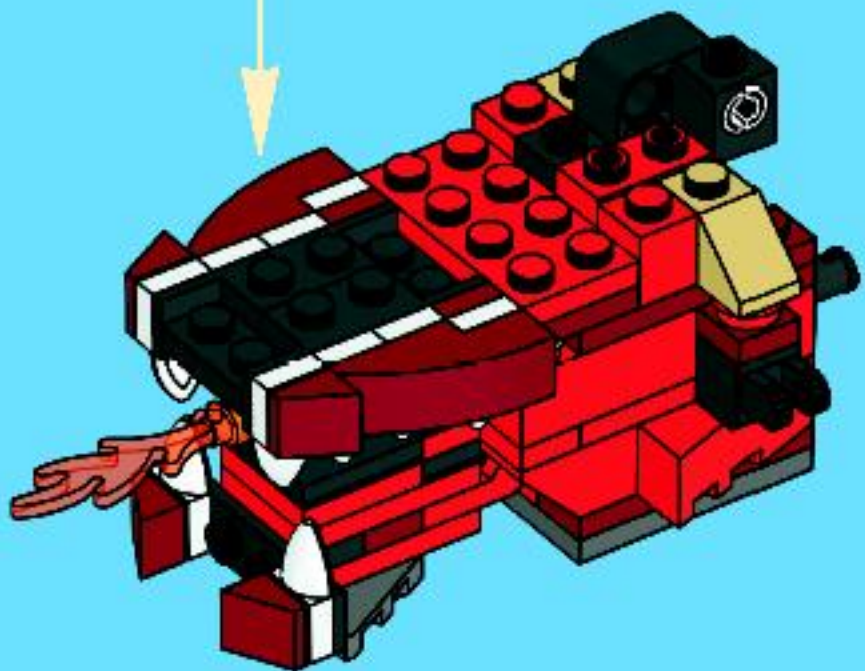
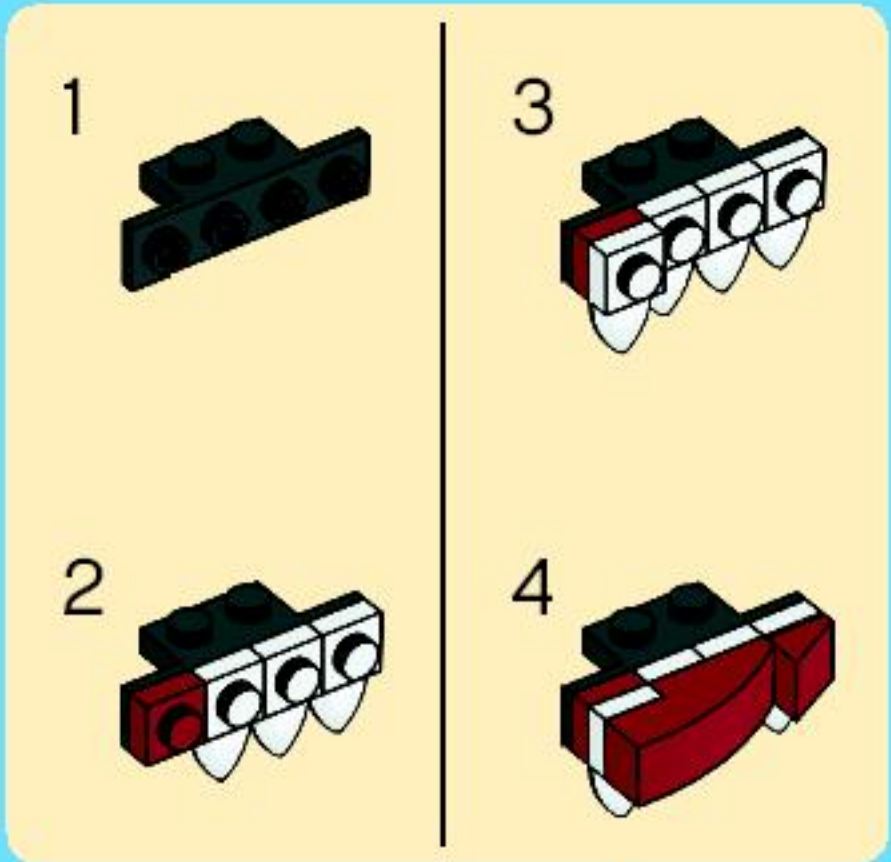

17

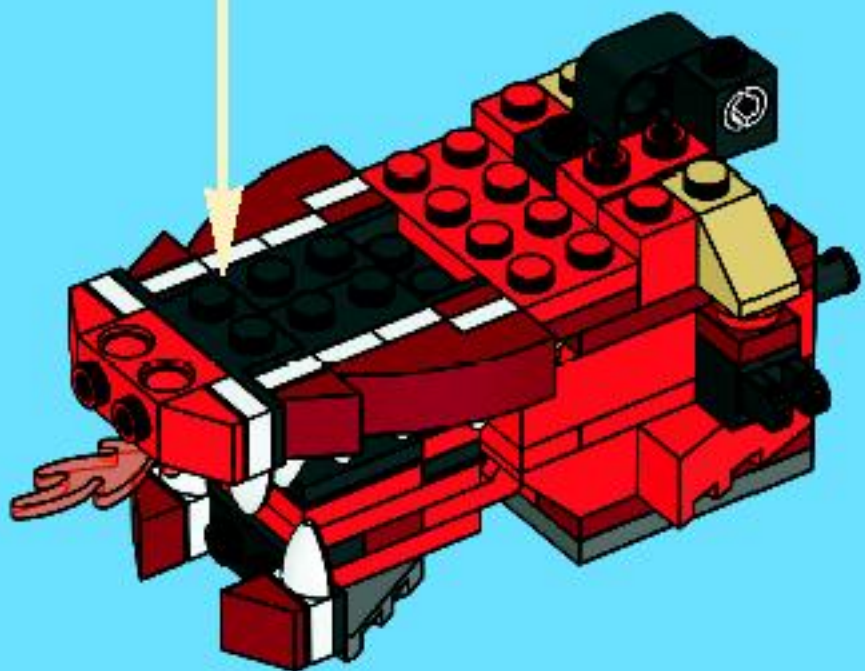
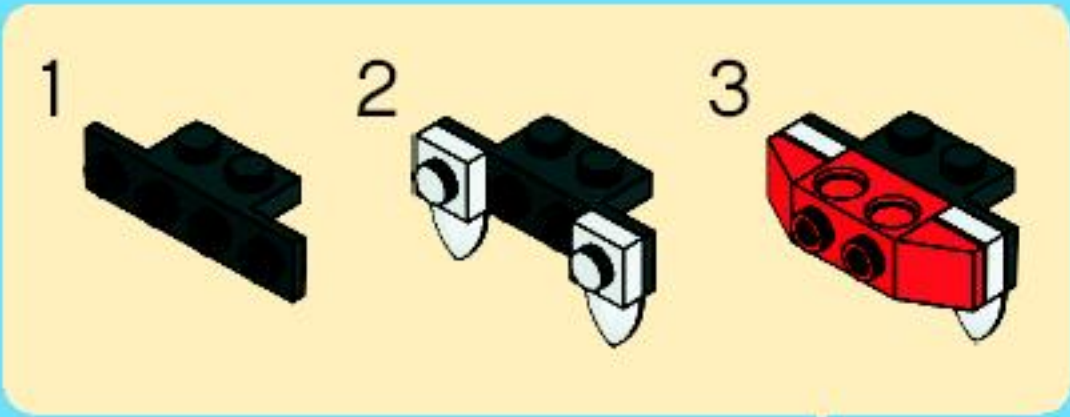



2x



4x

18

1



2



1



2

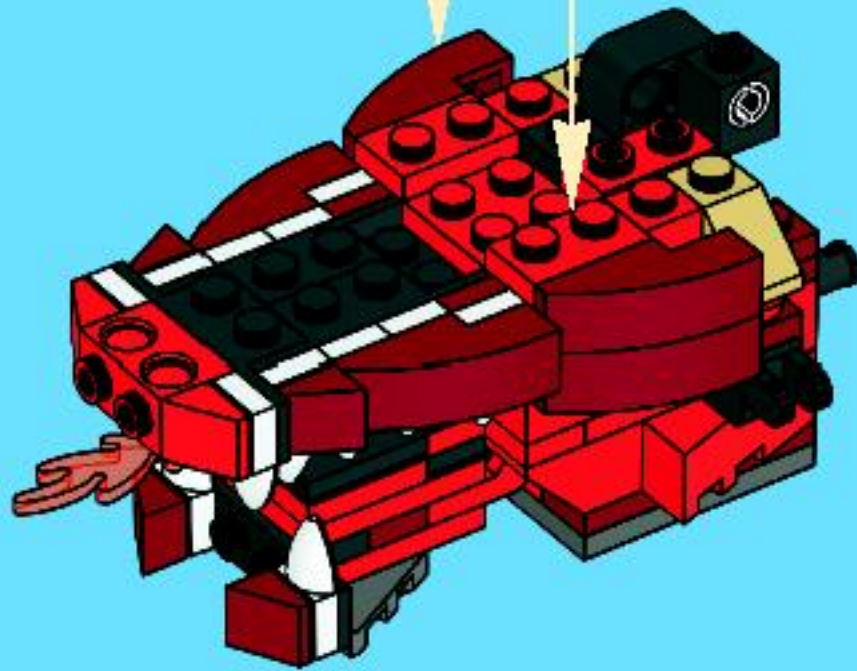



19

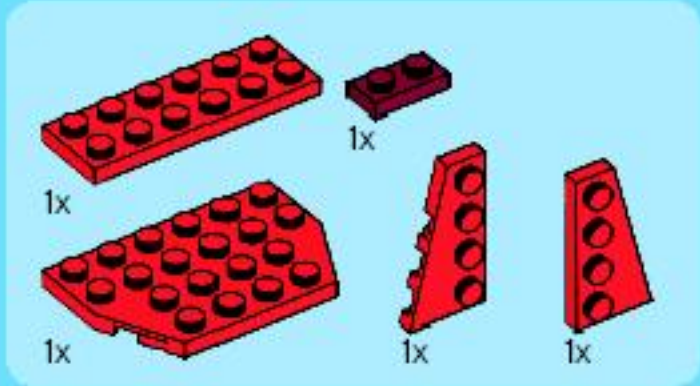
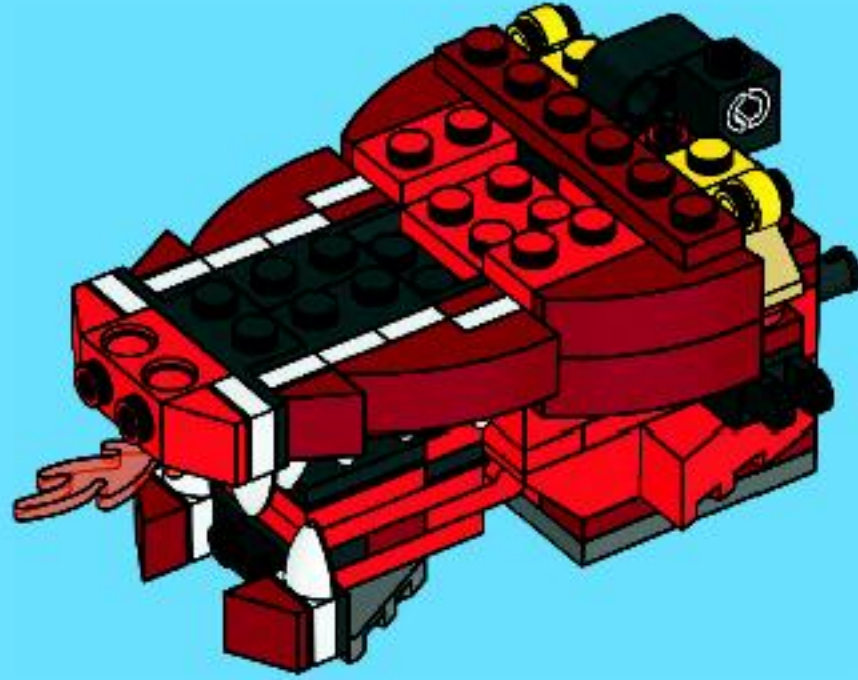

20

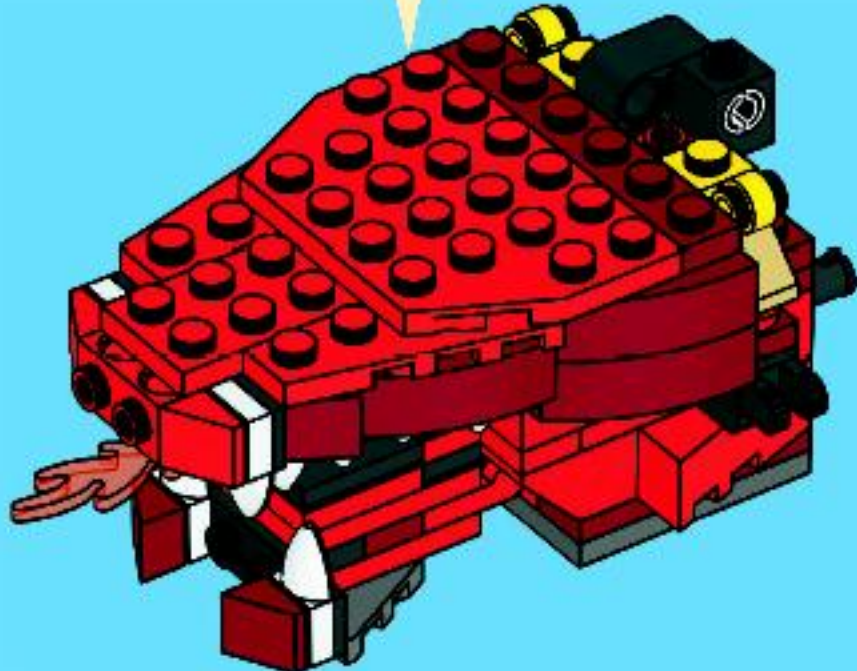
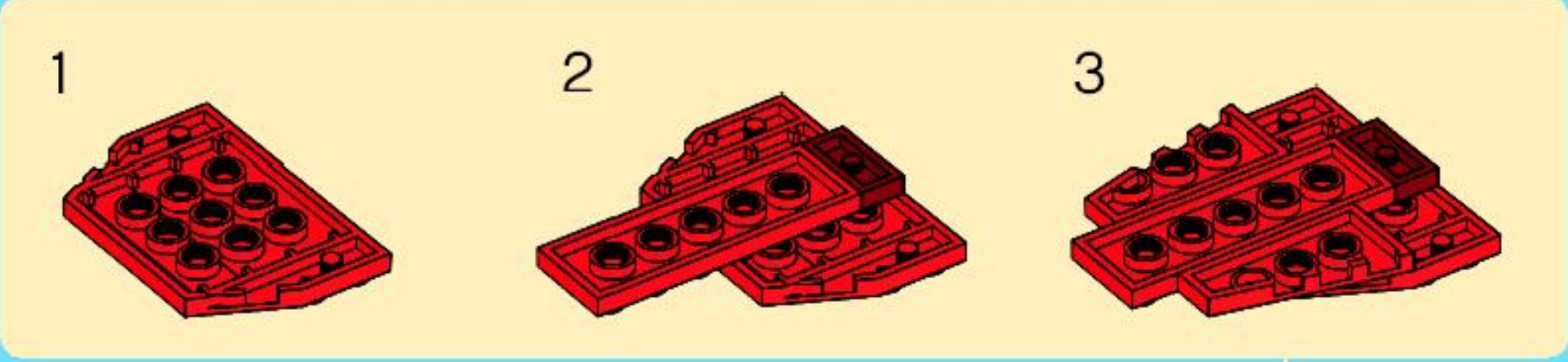



2x



1x



2x



2x

21

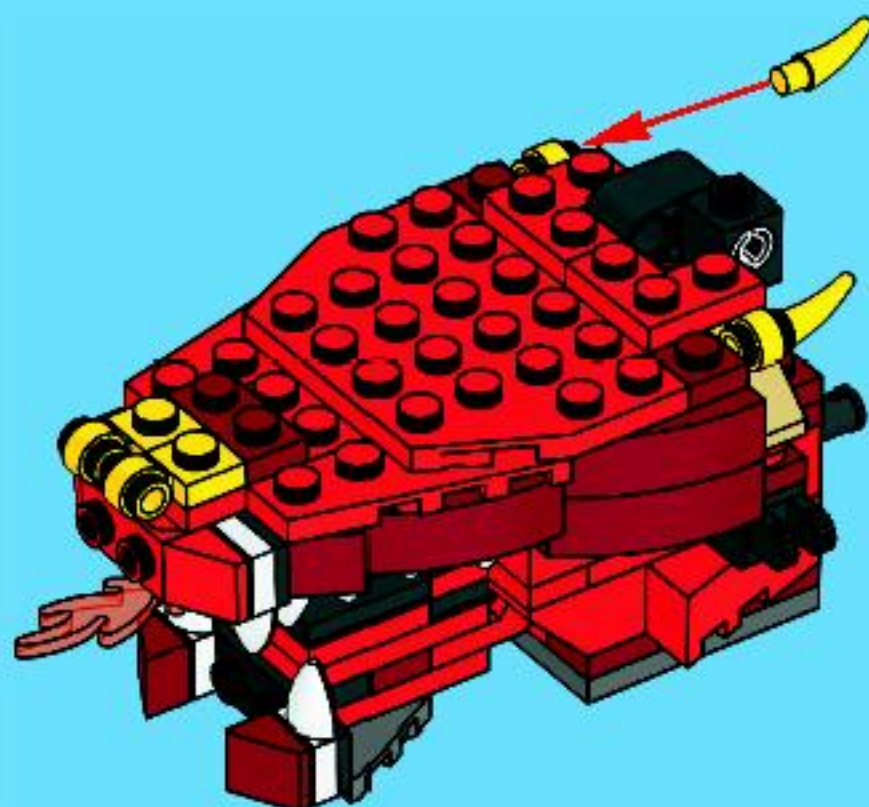

2x



2x

22

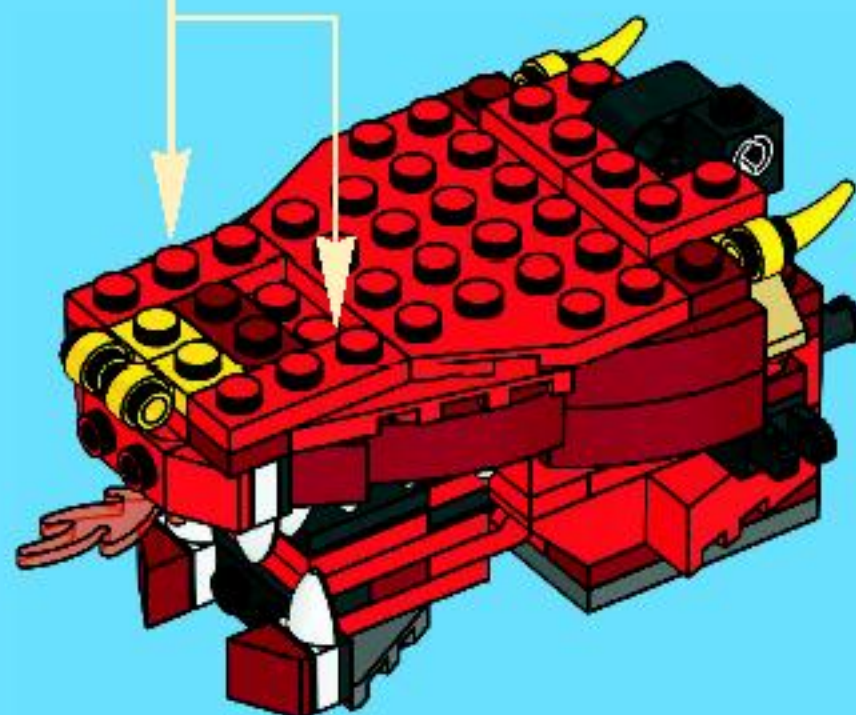
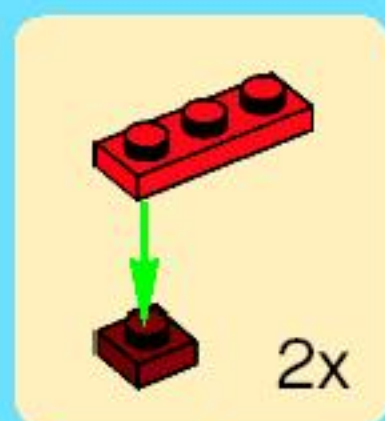



1x



2x



1x

23

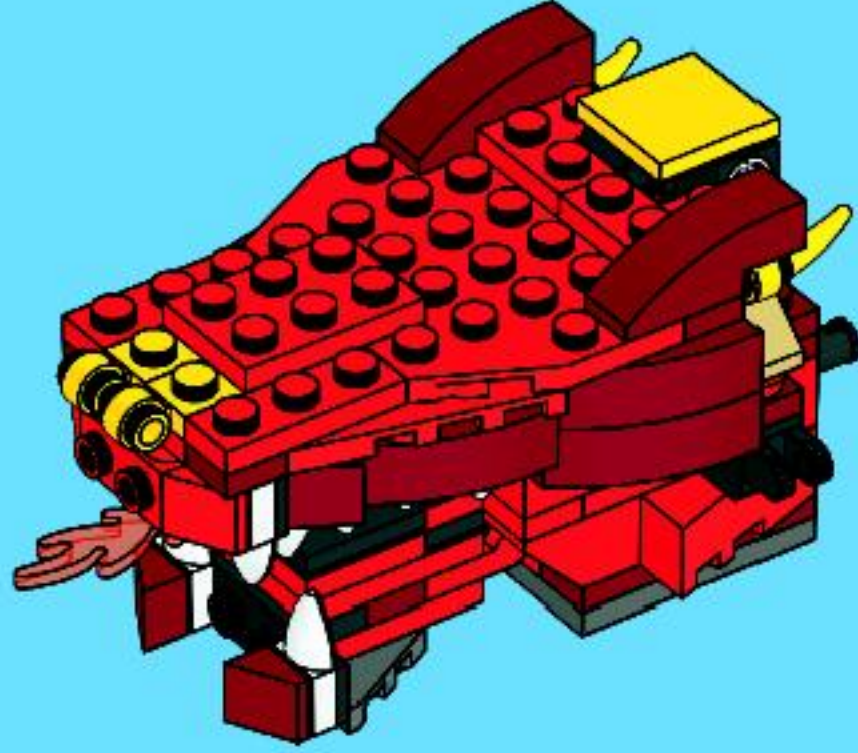

4x

24

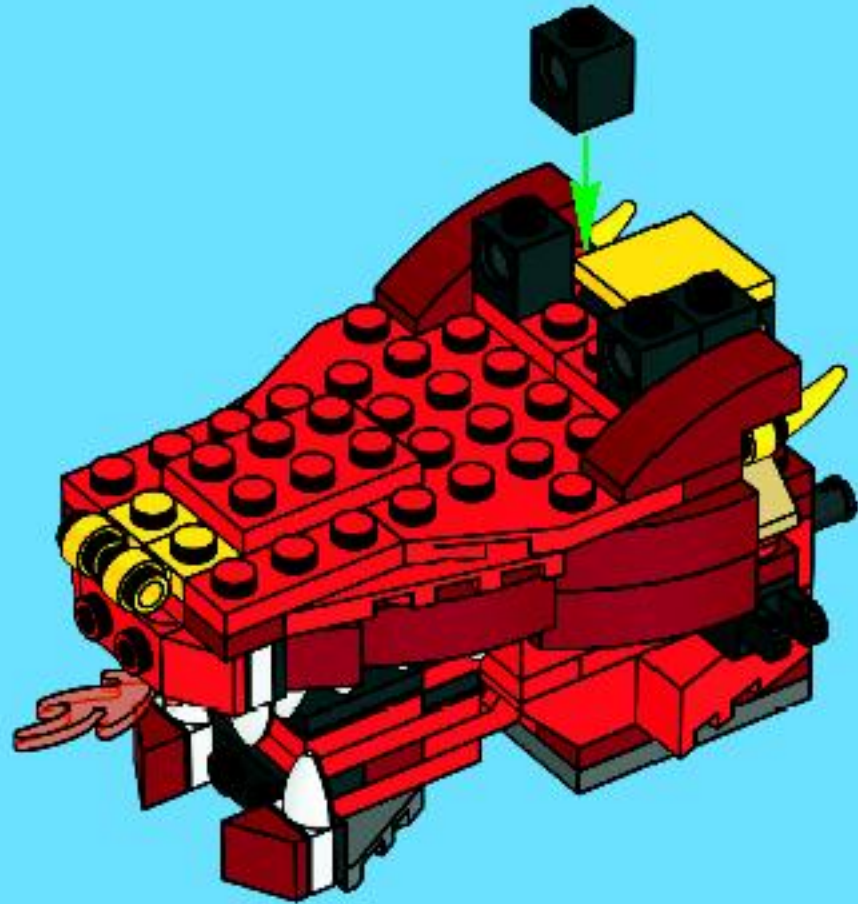



2x

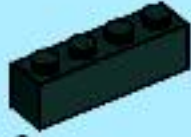

2x

25

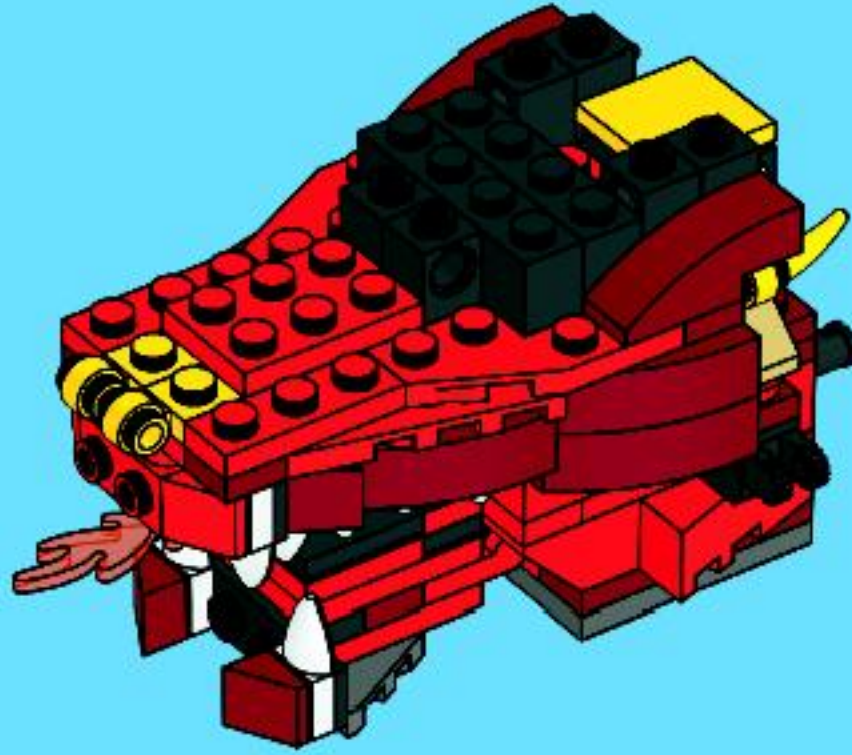

1x



1x



4x

26

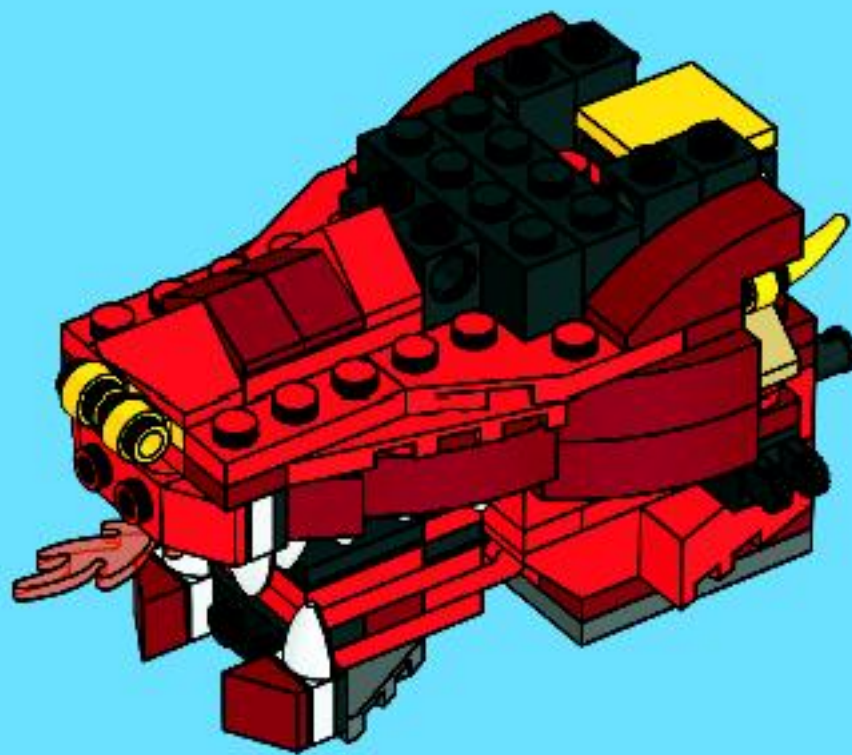



2x



2x

27

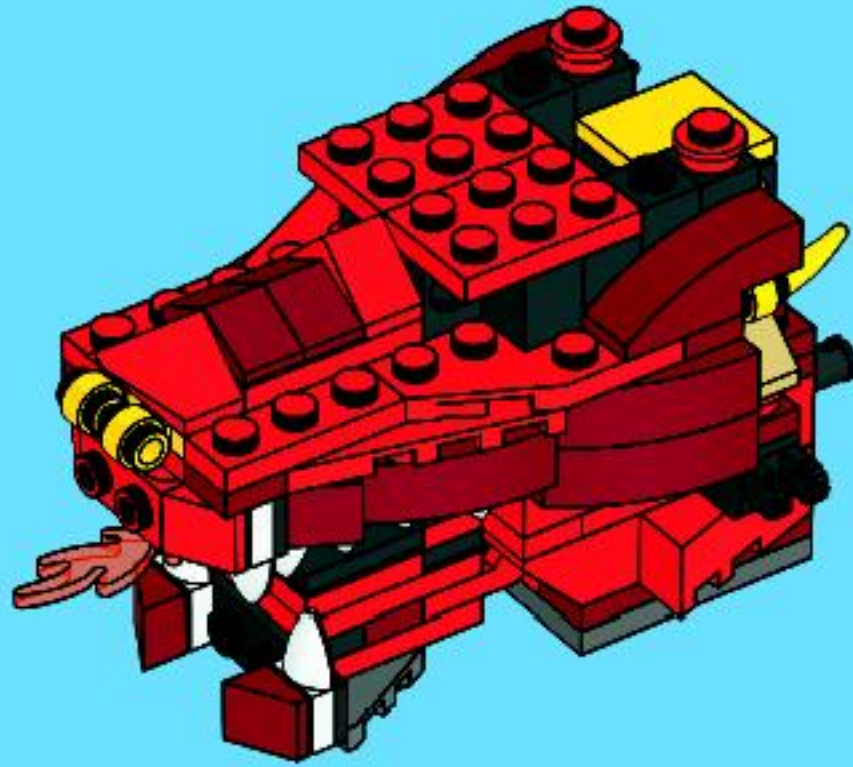

2x



2x



2x



1x

28

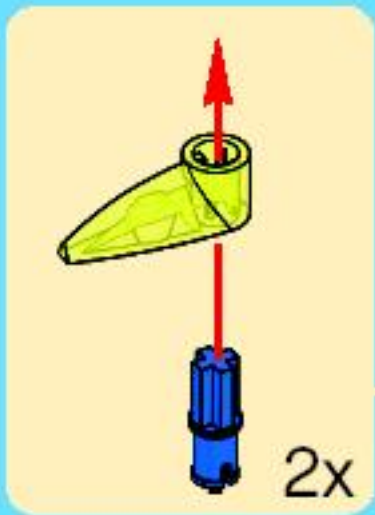

2x

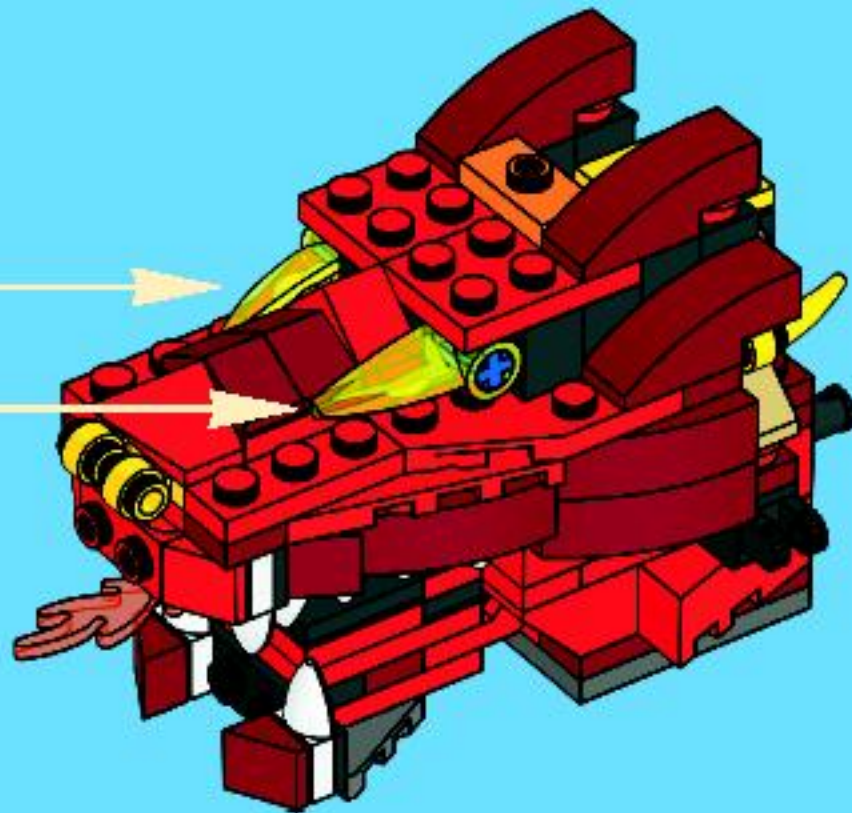



1x



2x

29

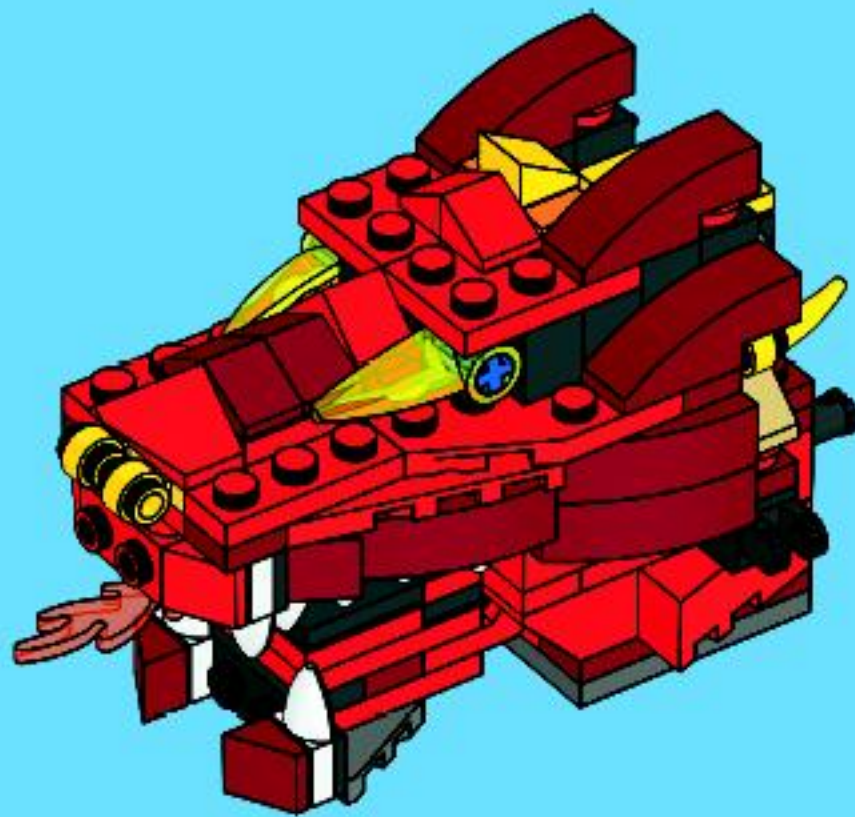

2x



2x

30

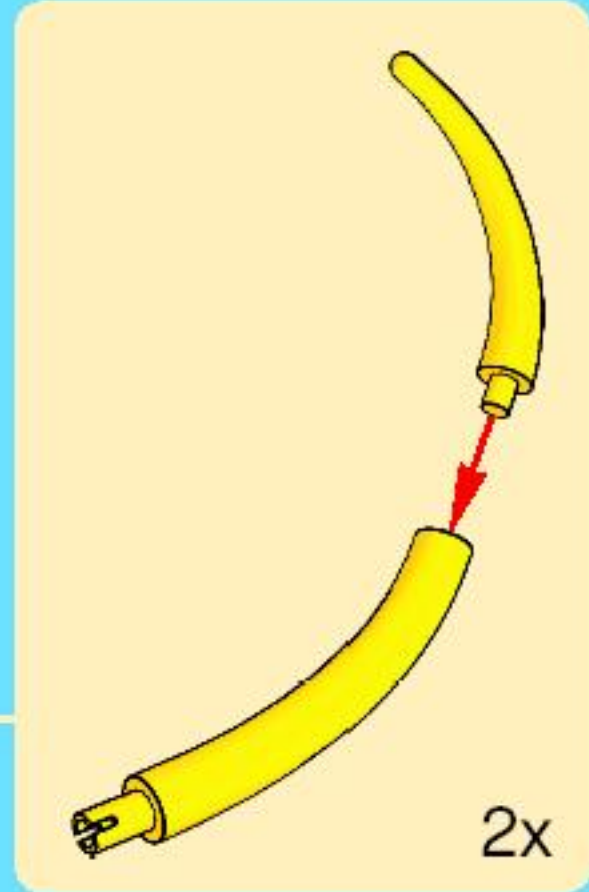
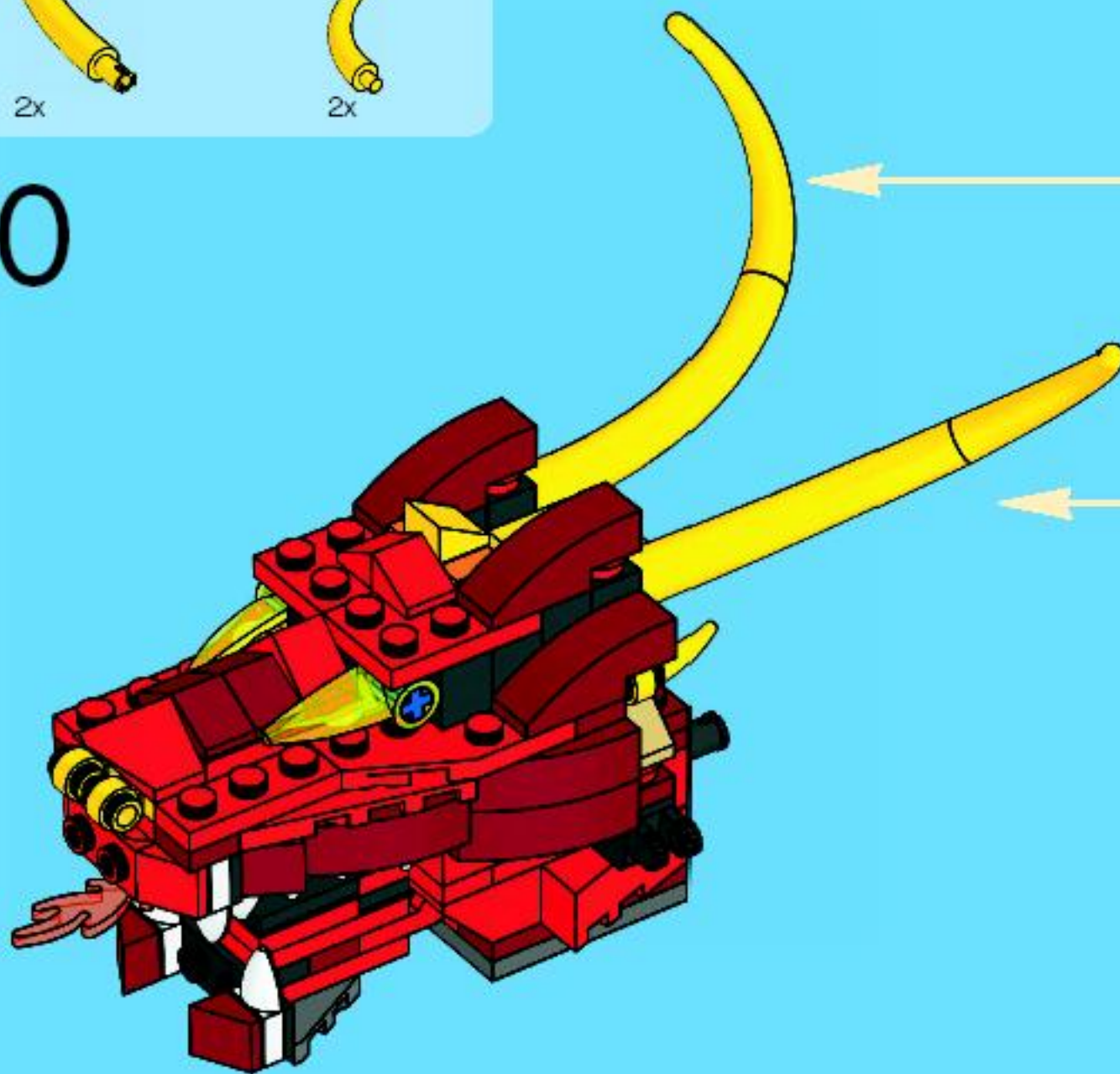



2x



2x

31

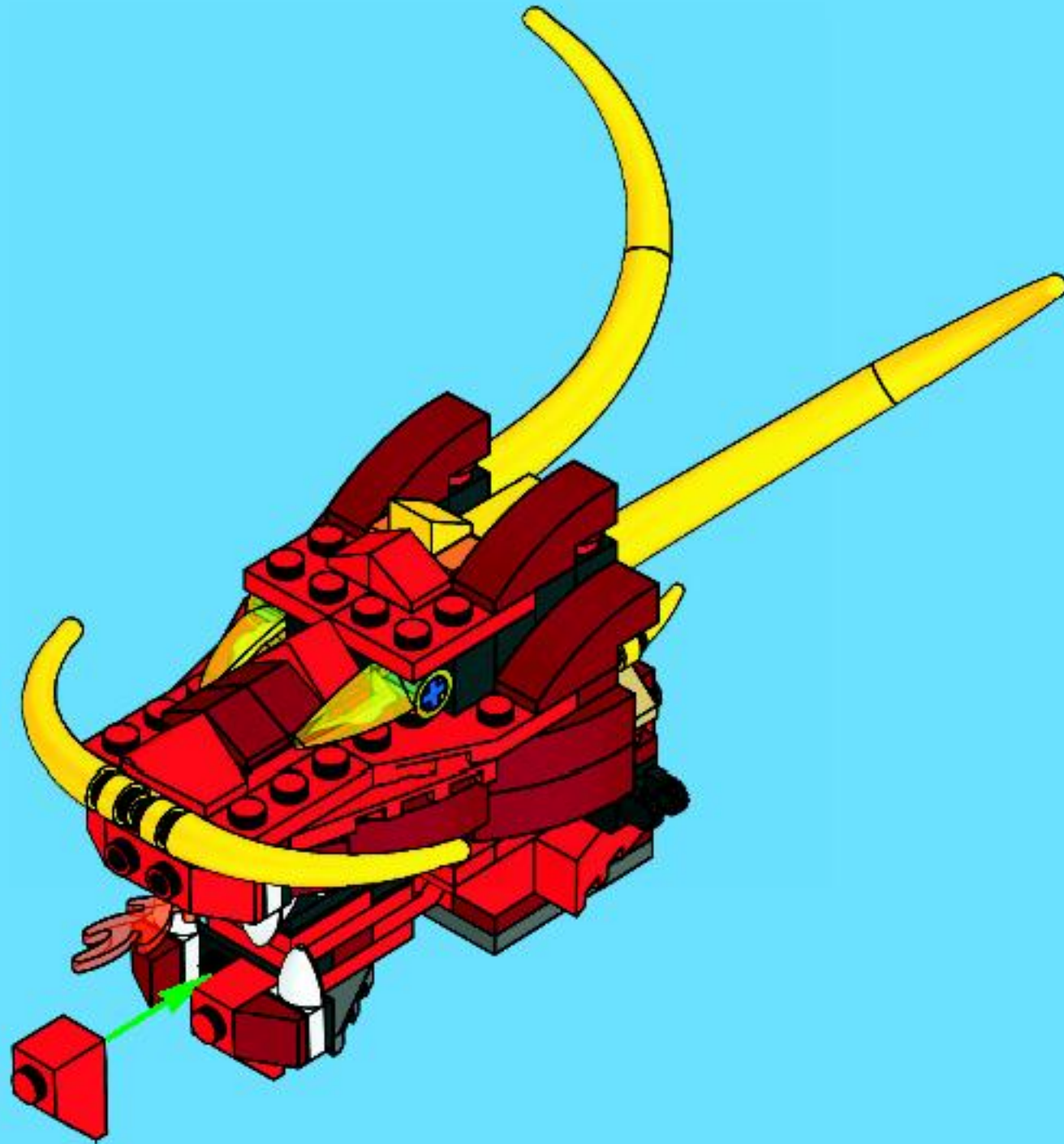



1



2



3



4

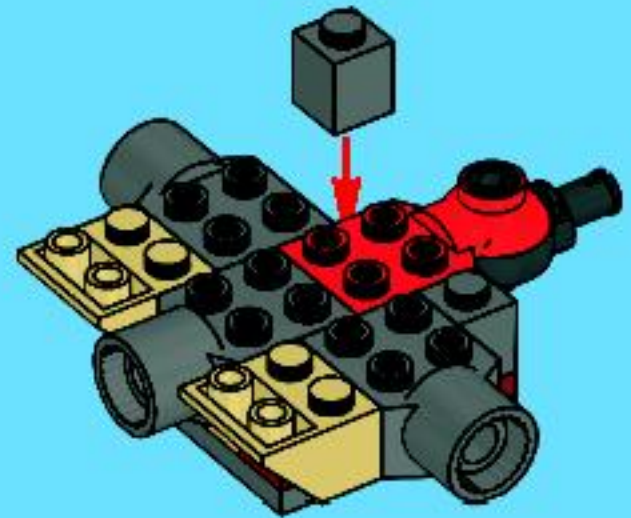

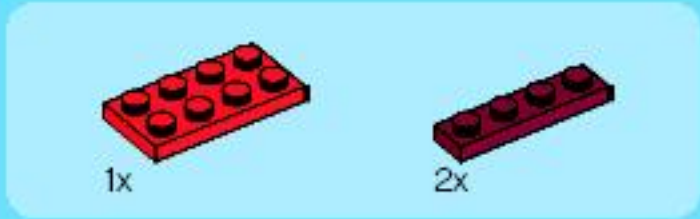

5

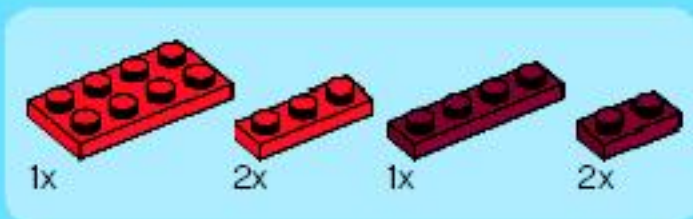
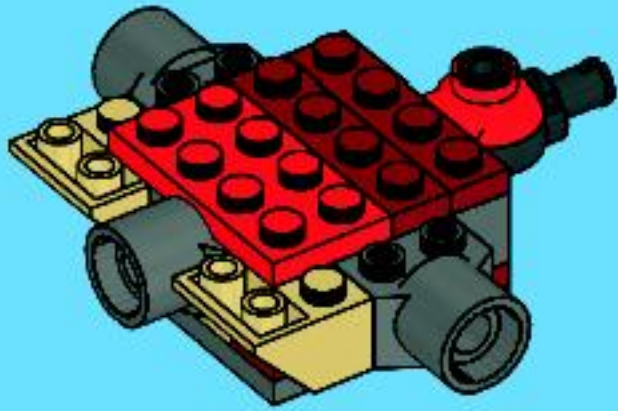

7

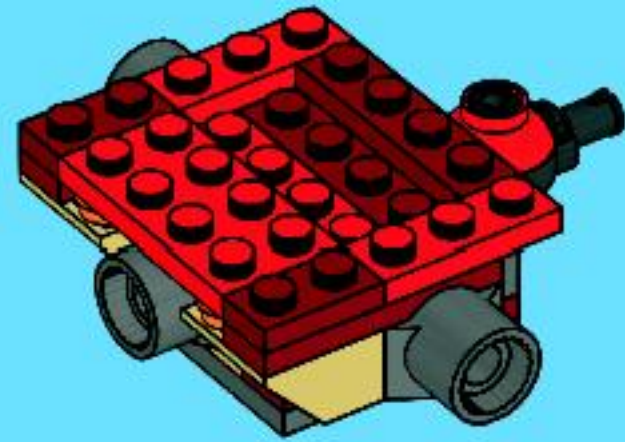

6

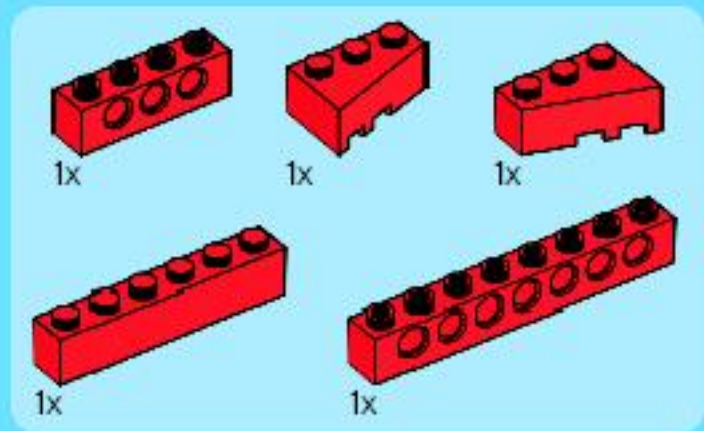
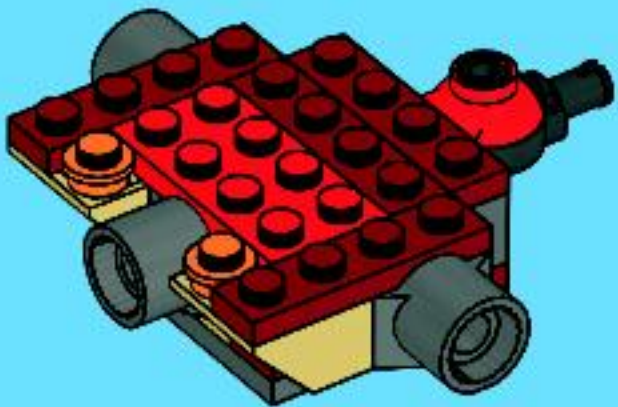

8

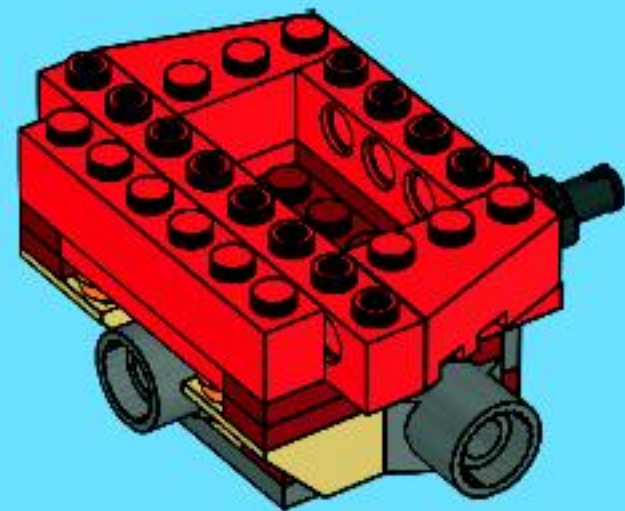



1x



2x

9

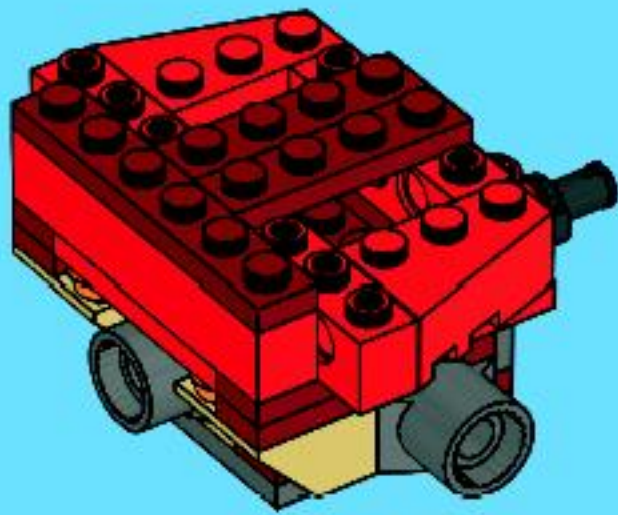

2x



1x

11

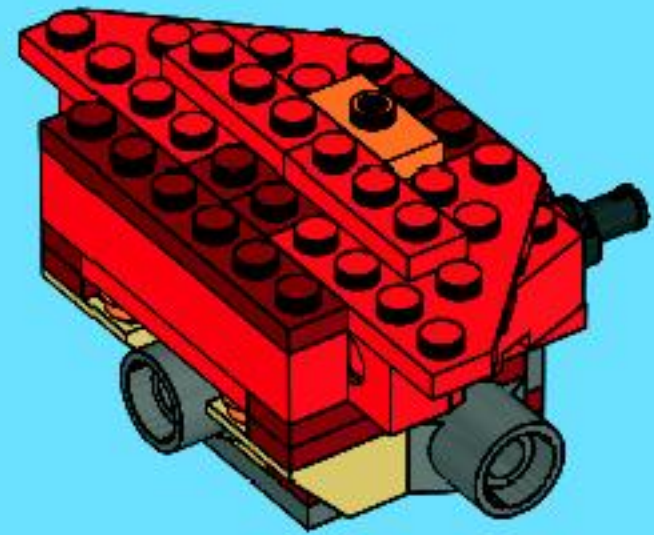

2x

10

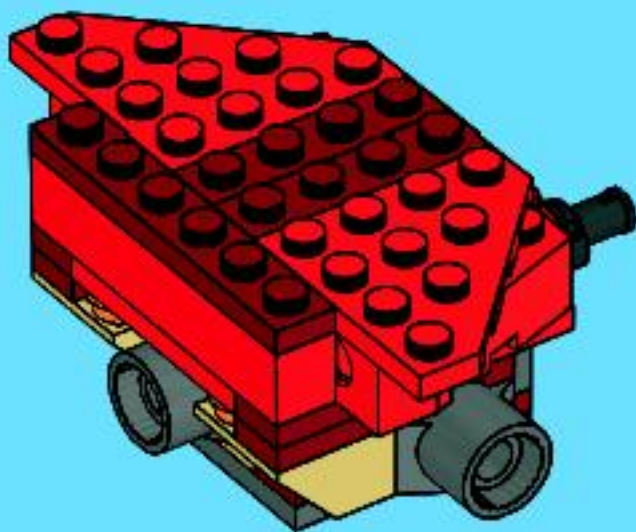

2x



1x

12

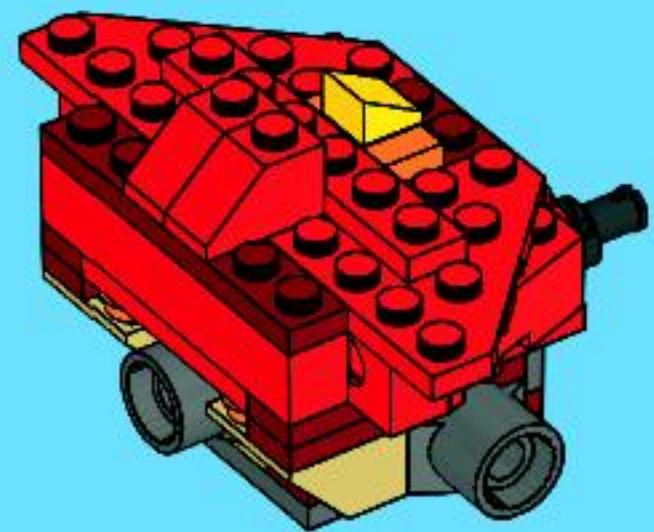



1x



1x

13

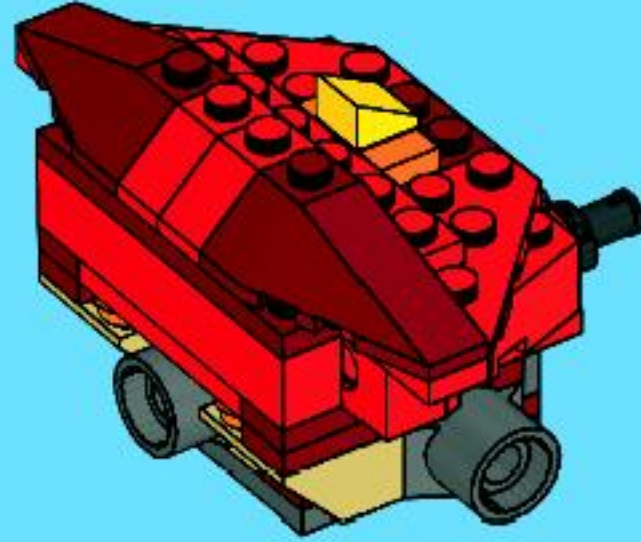

14

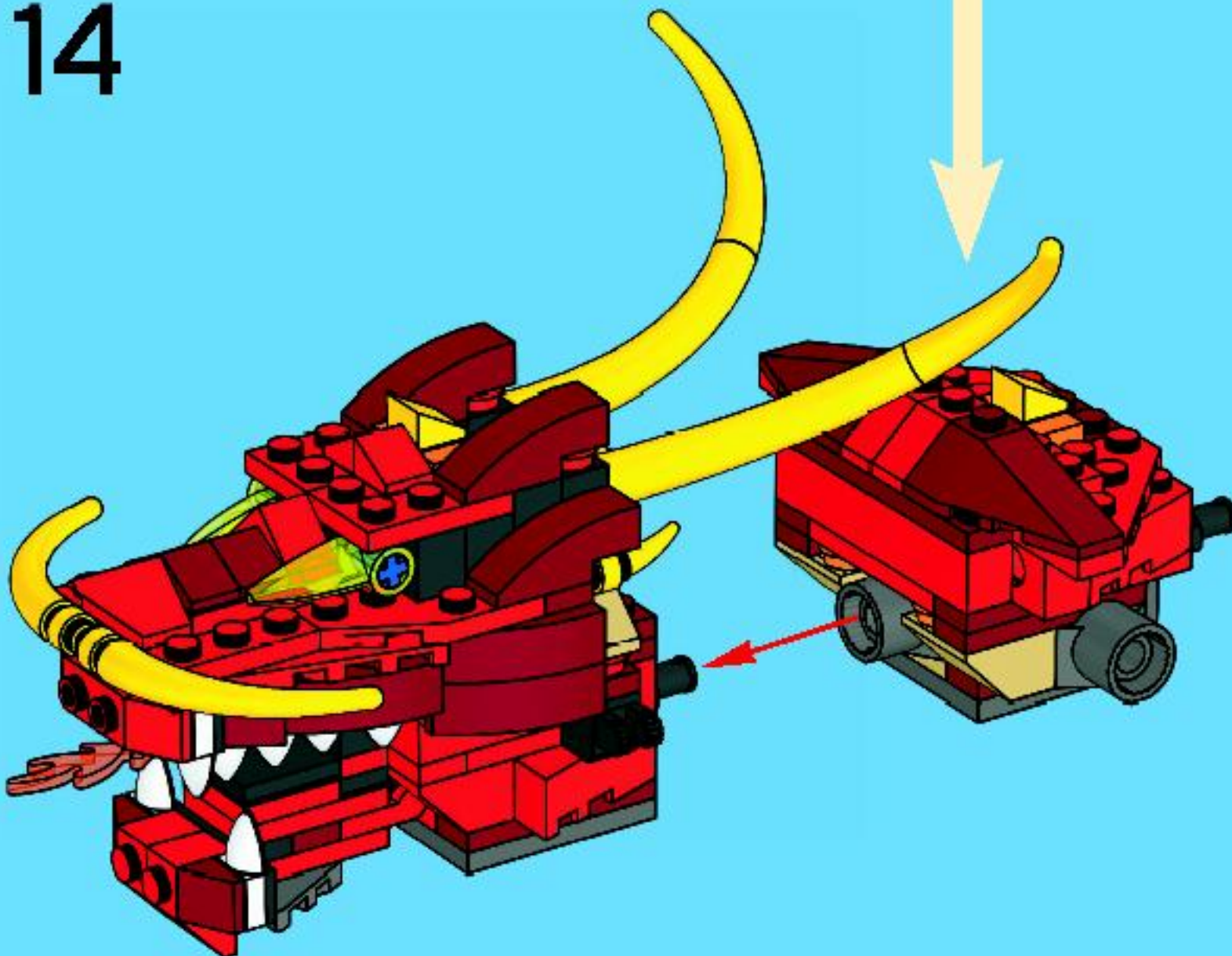

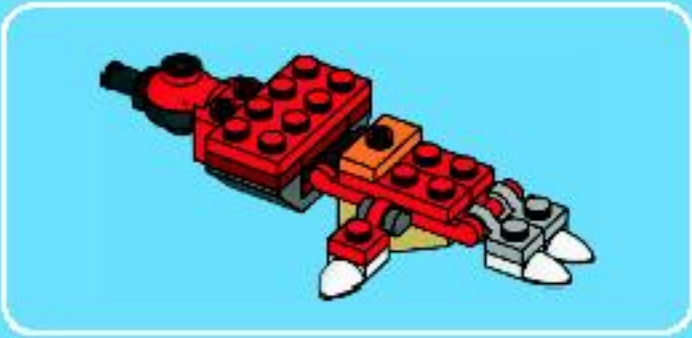

1

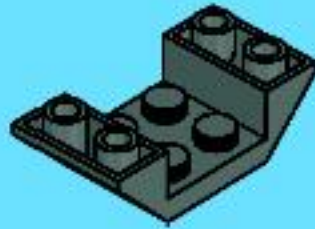

2

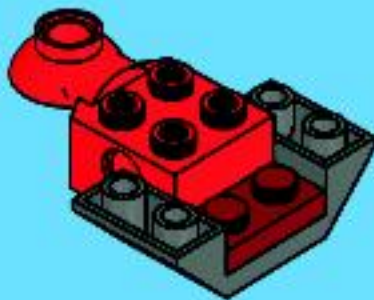

3



4



5

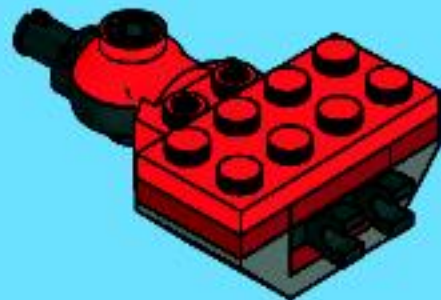



1

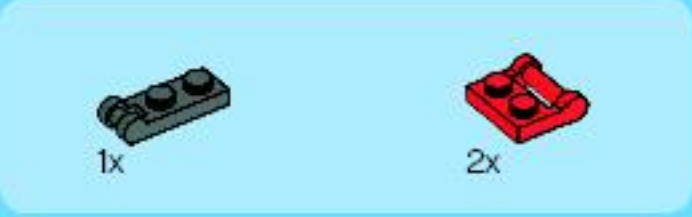

2

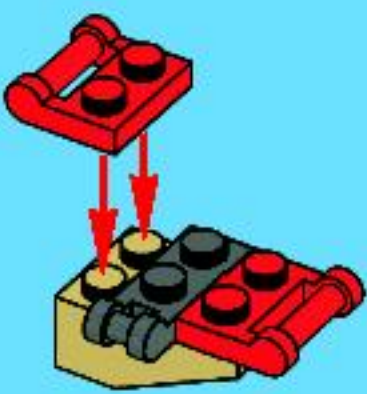

3



4

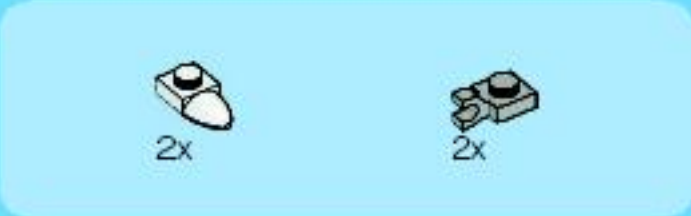
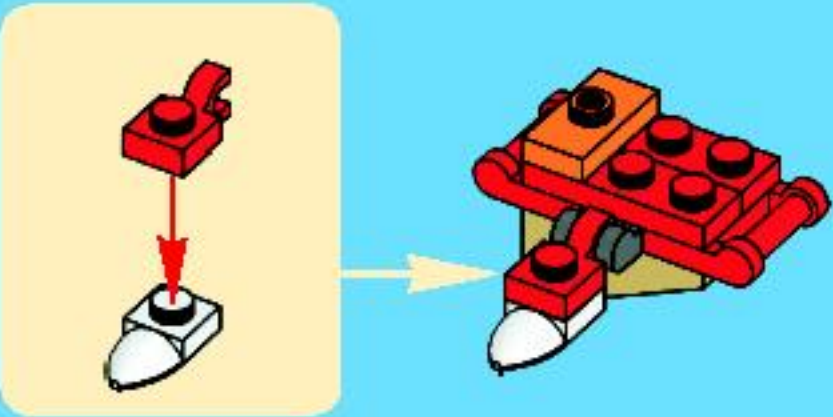

5

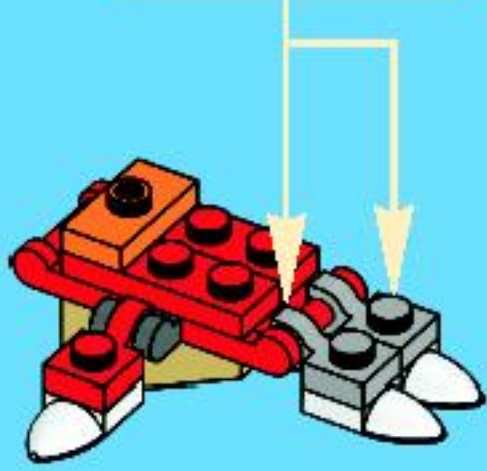

6

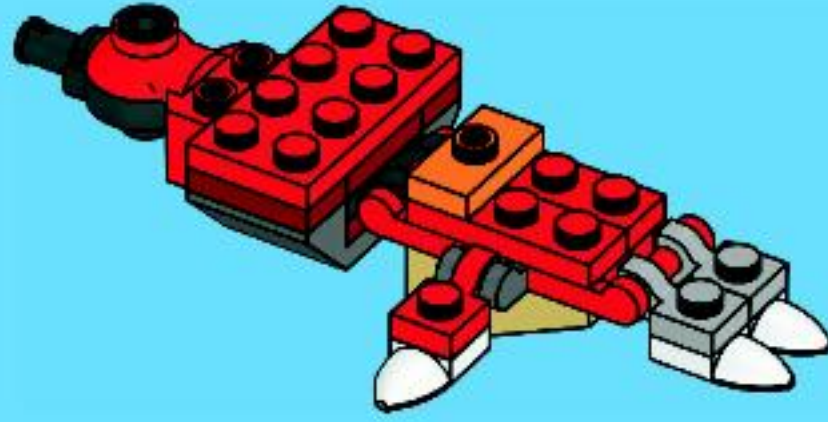

7

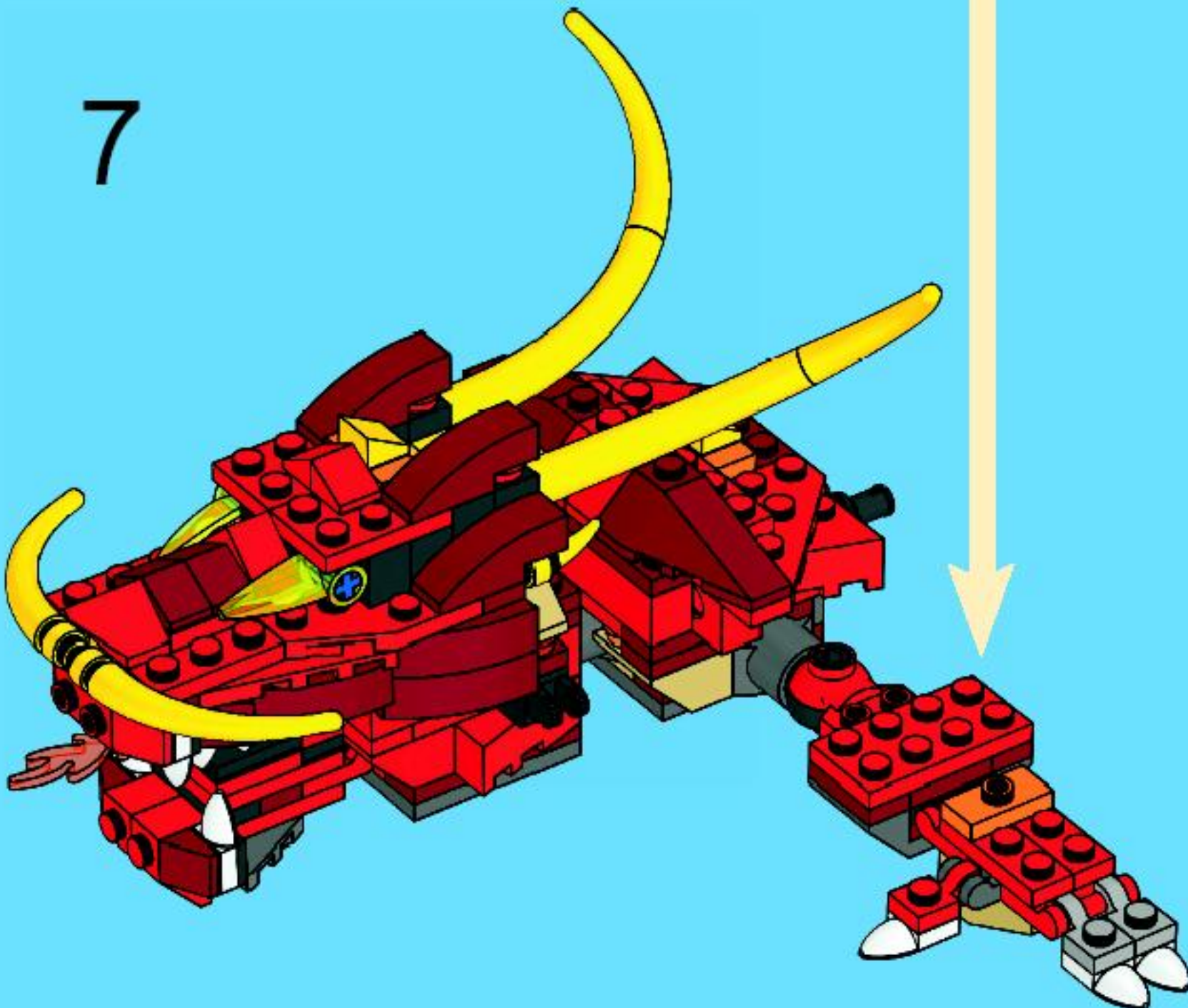

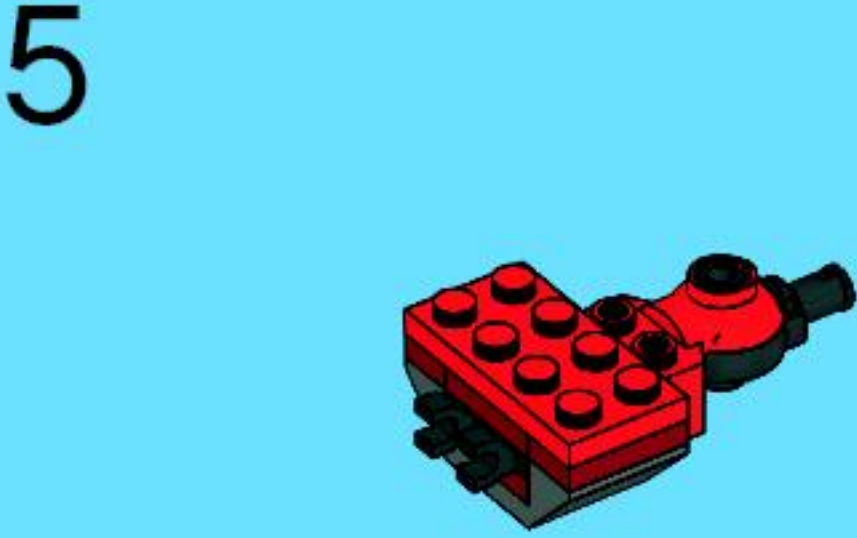
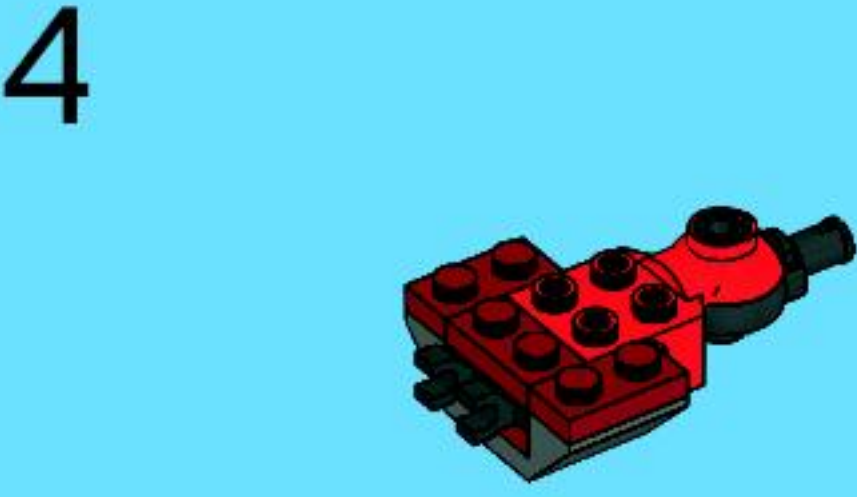
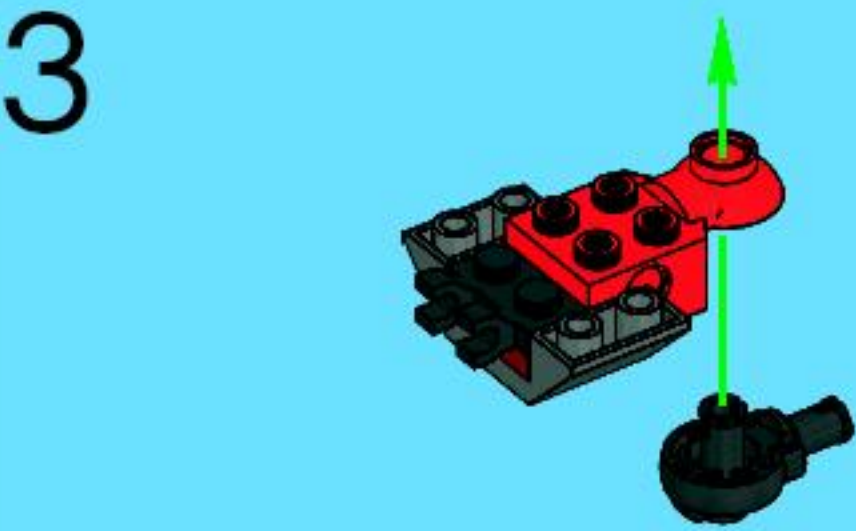
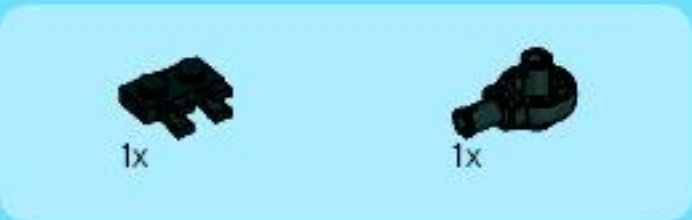
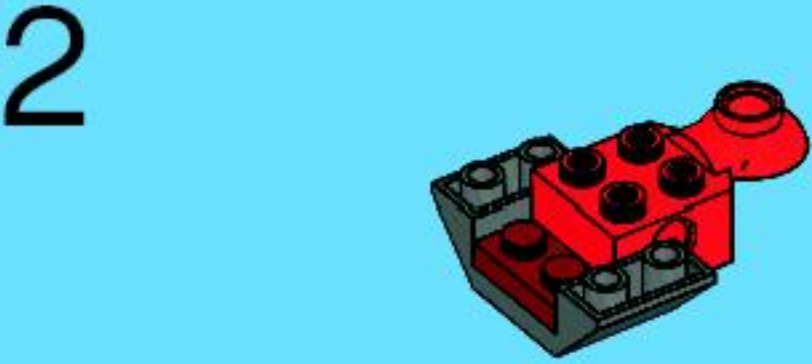
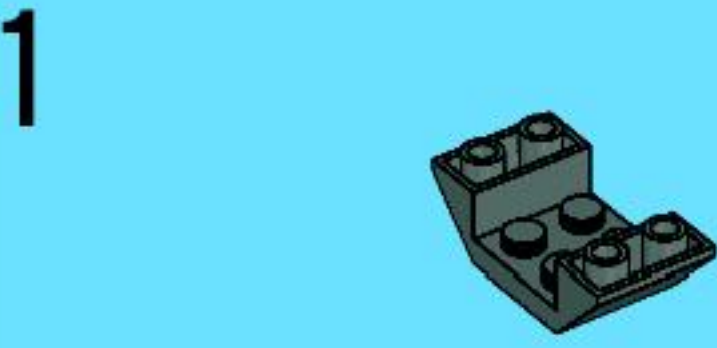
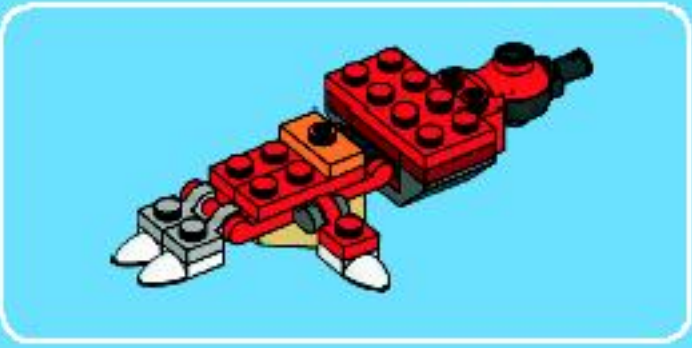

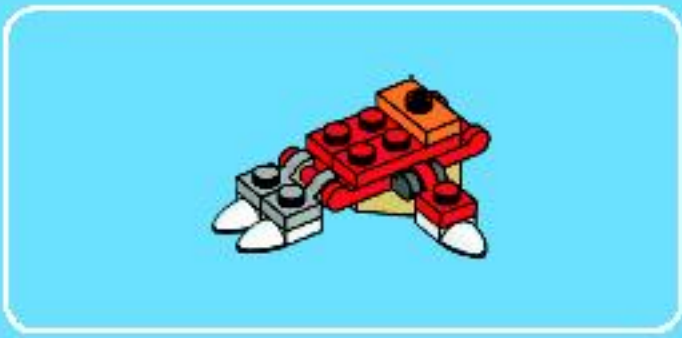

1

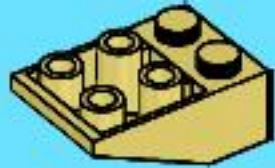

2

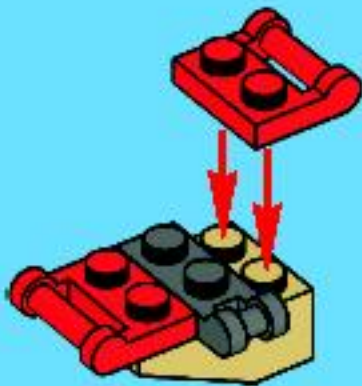

3



4

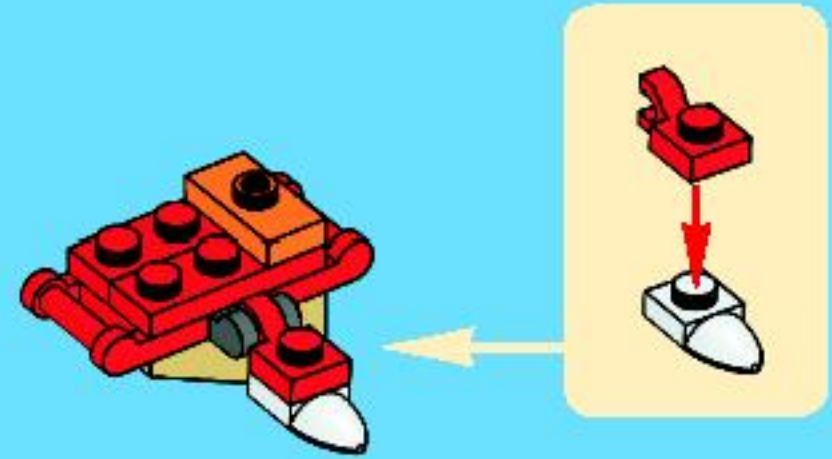

5

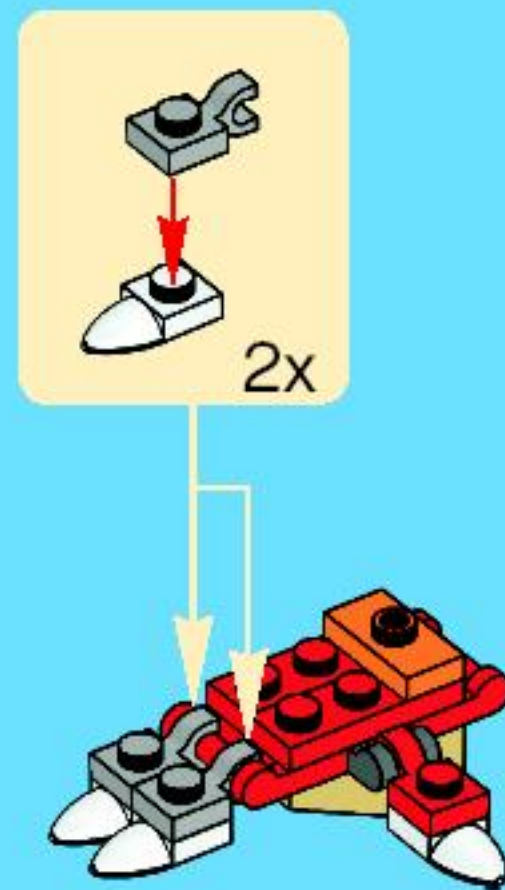

6

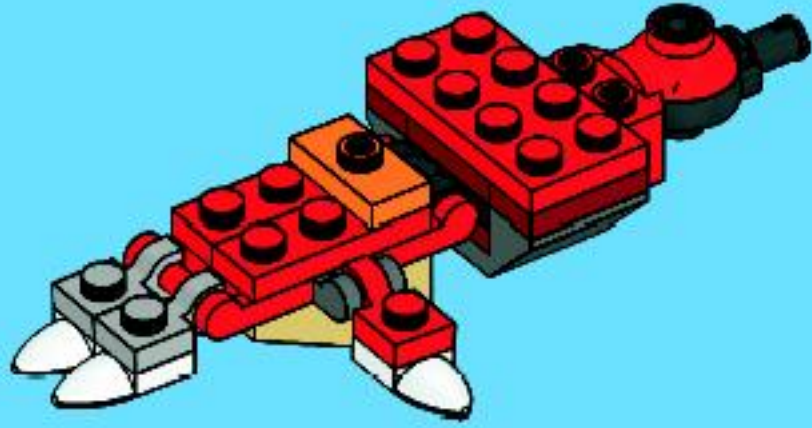

7

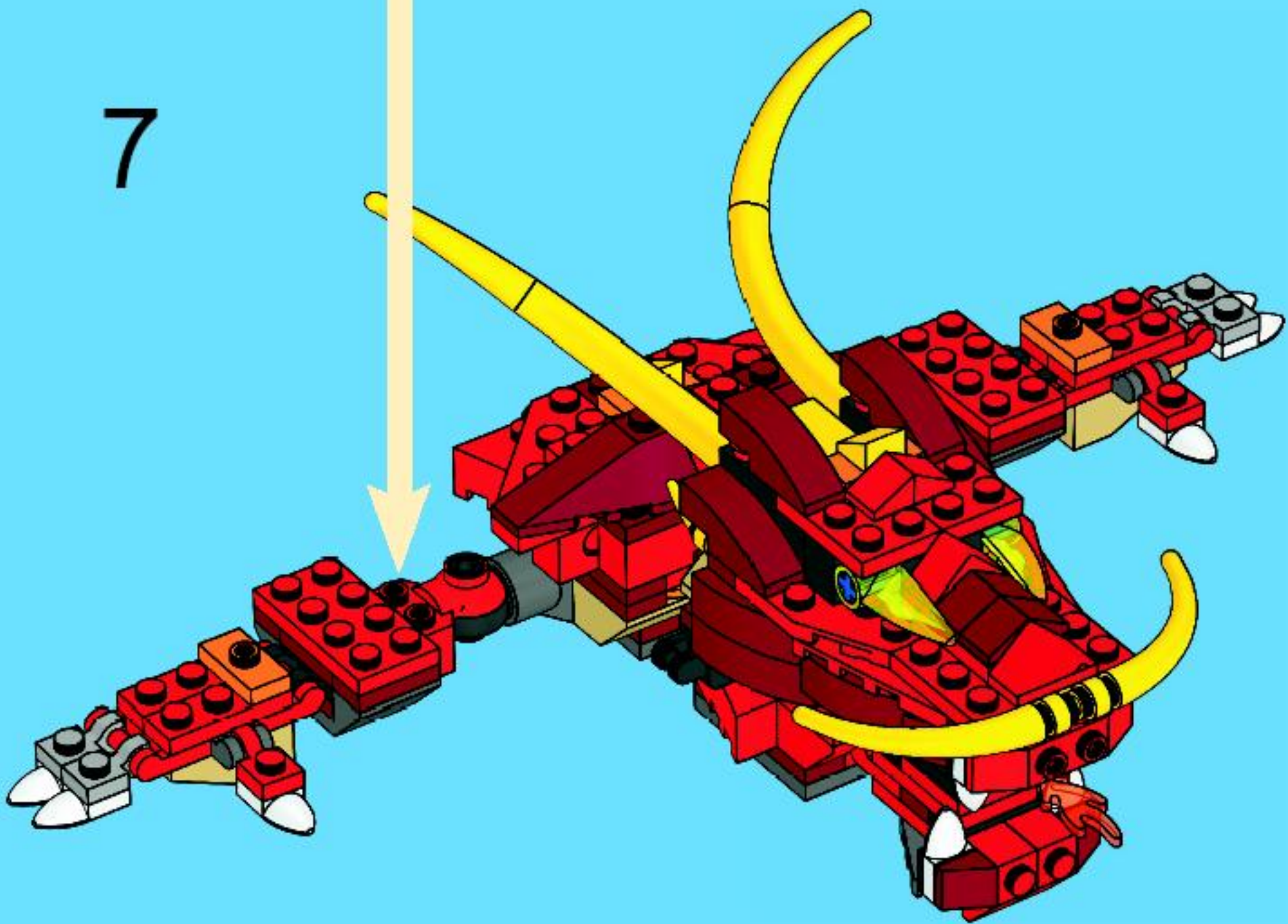

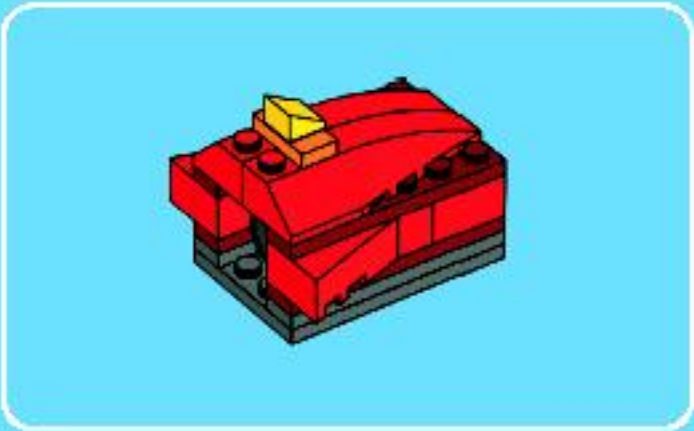

1

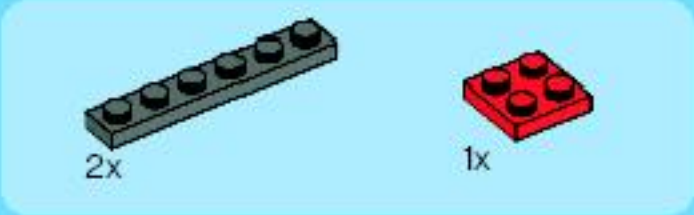

2

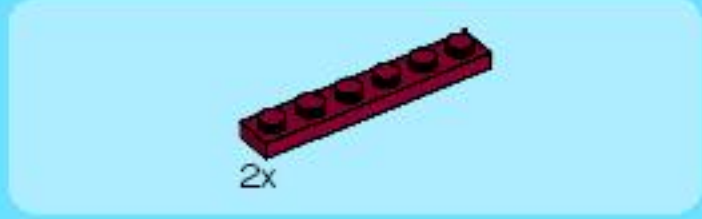
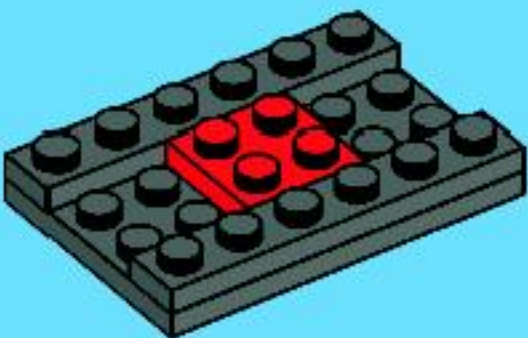

3

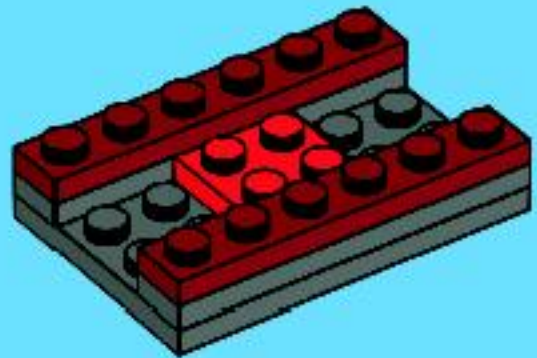

4

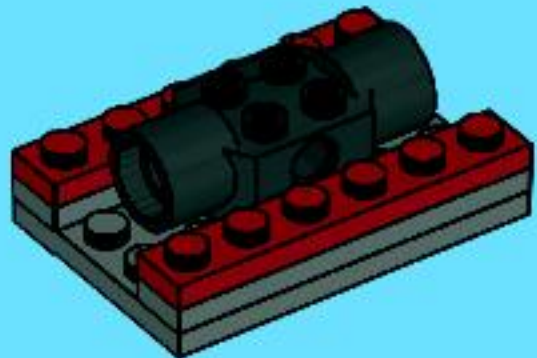



2x



2x

5

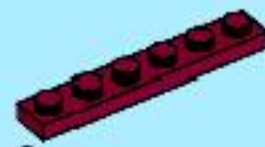
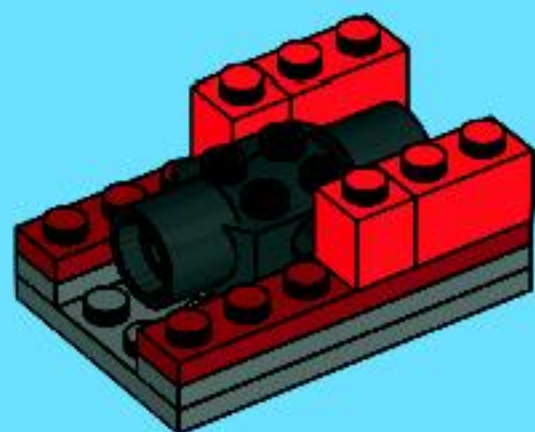

2x



1x

7

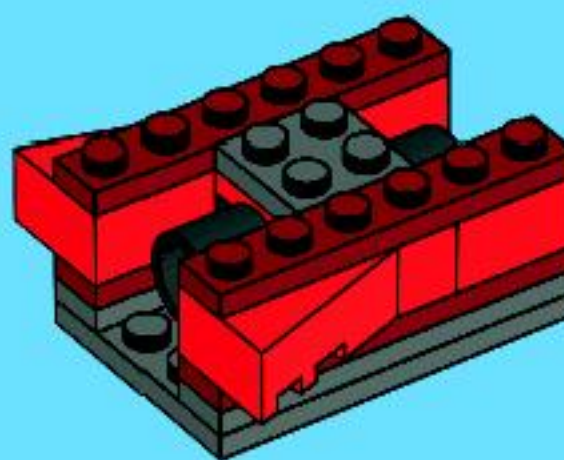

1x



1x



1x

6

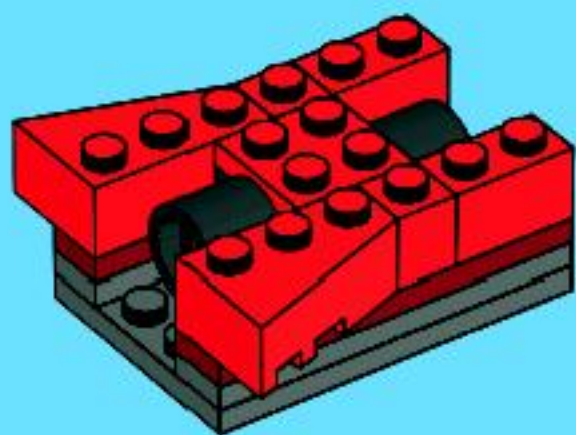

1x



1x

8

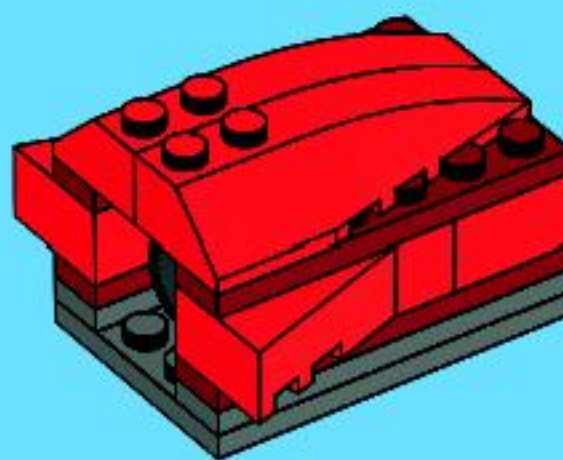



1x



1x

9

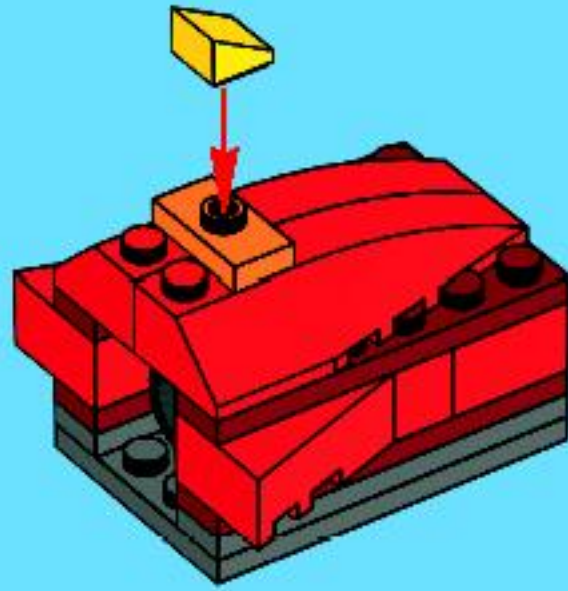

10

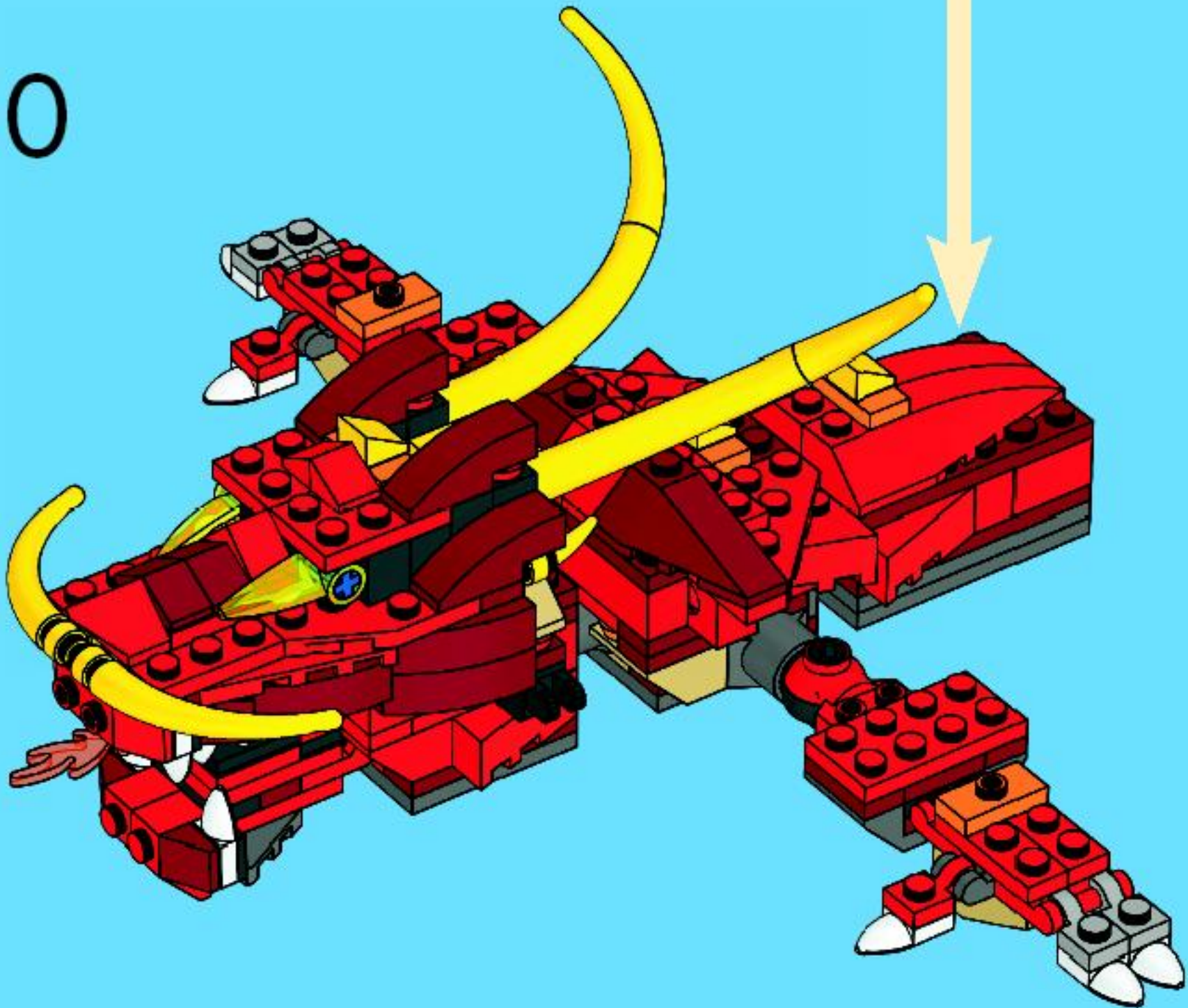

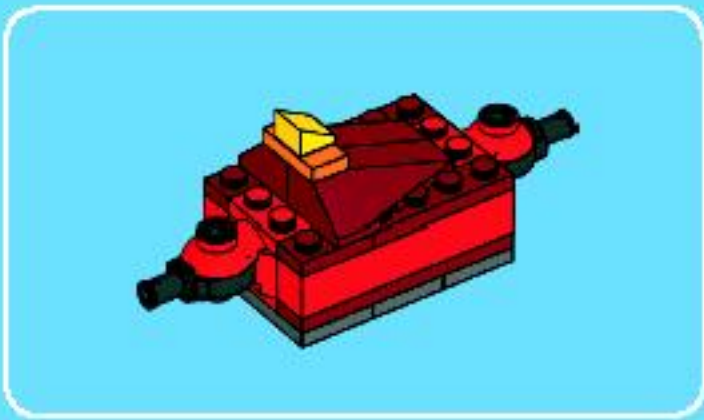

1

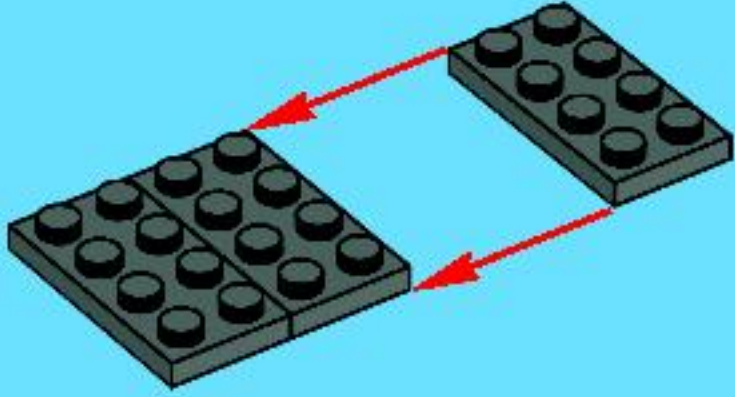

2

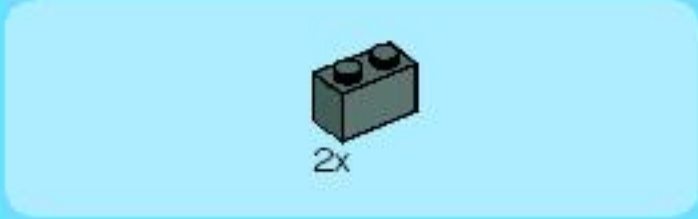

3

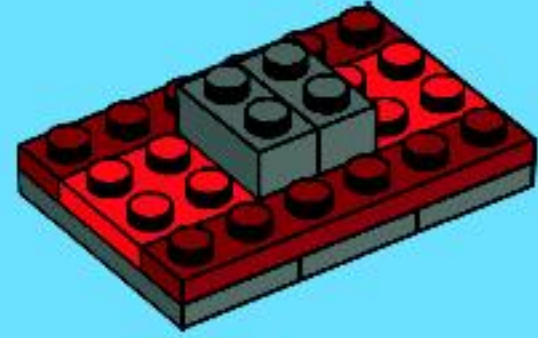

4

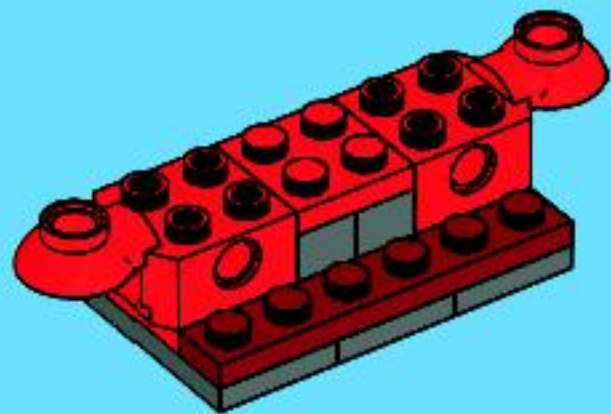

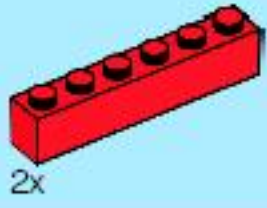

5

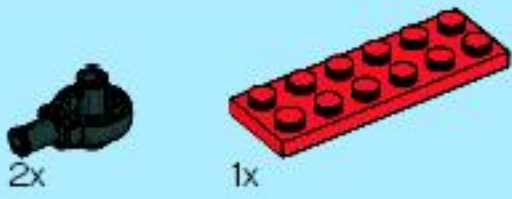
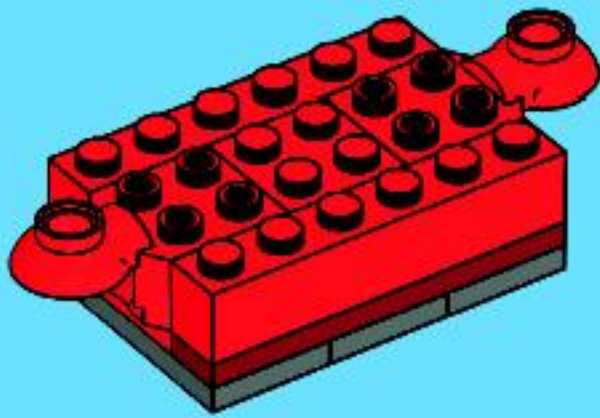

6

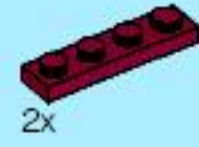
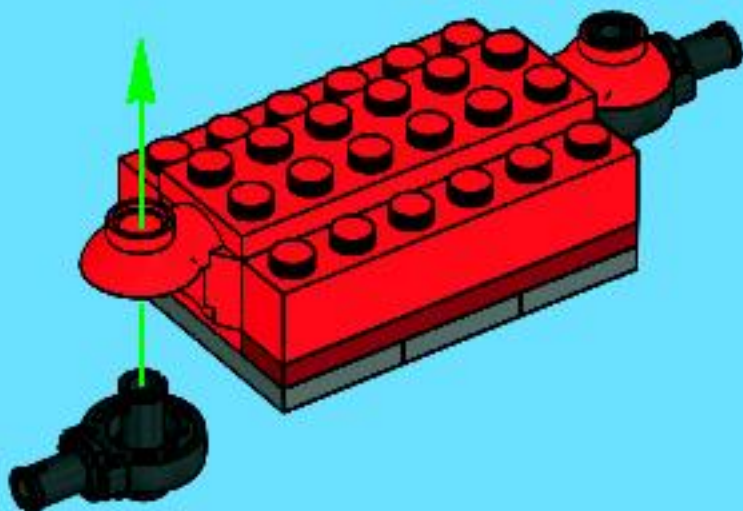

7

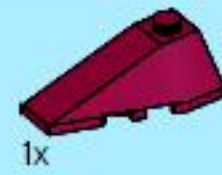
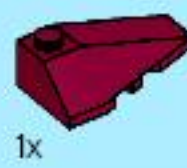
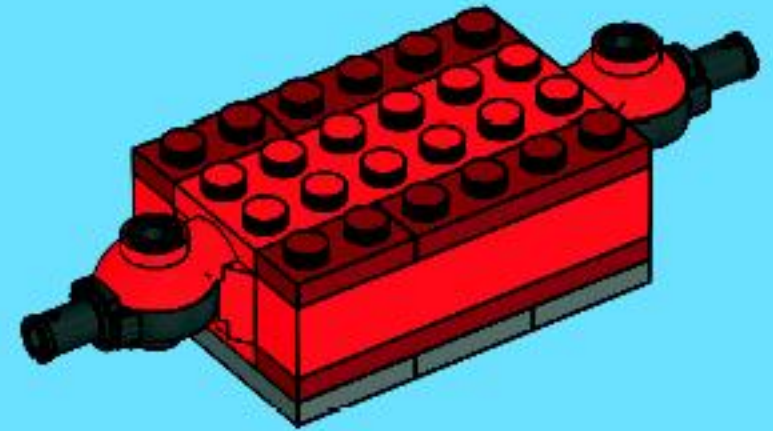

8

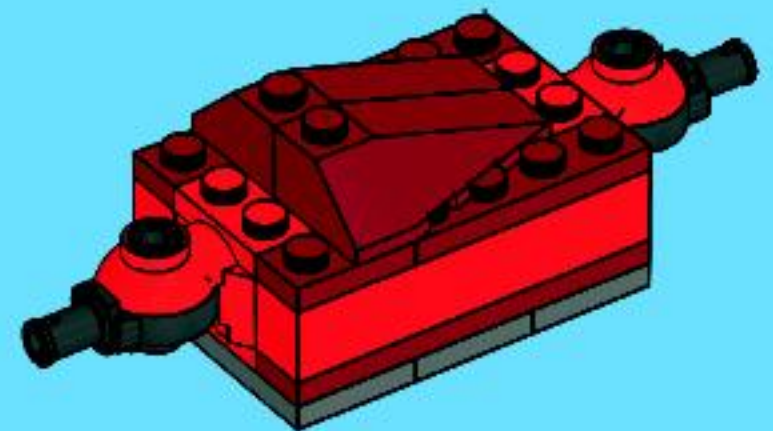



1x



1x

9

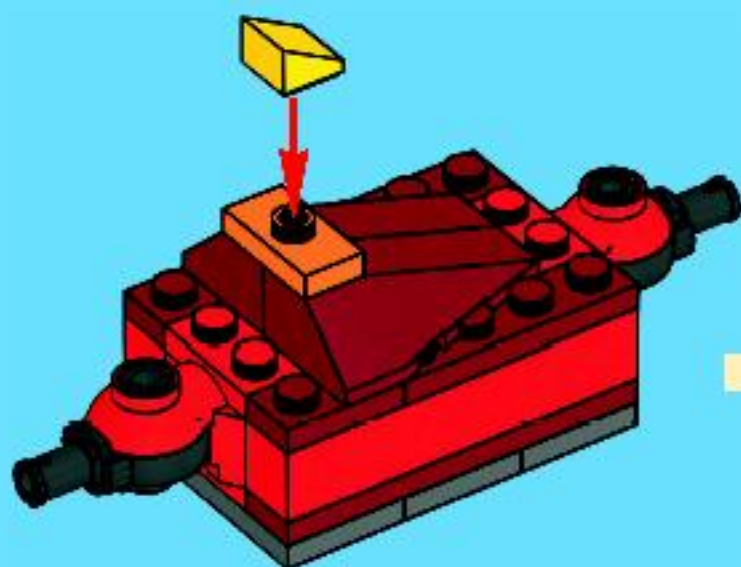

10

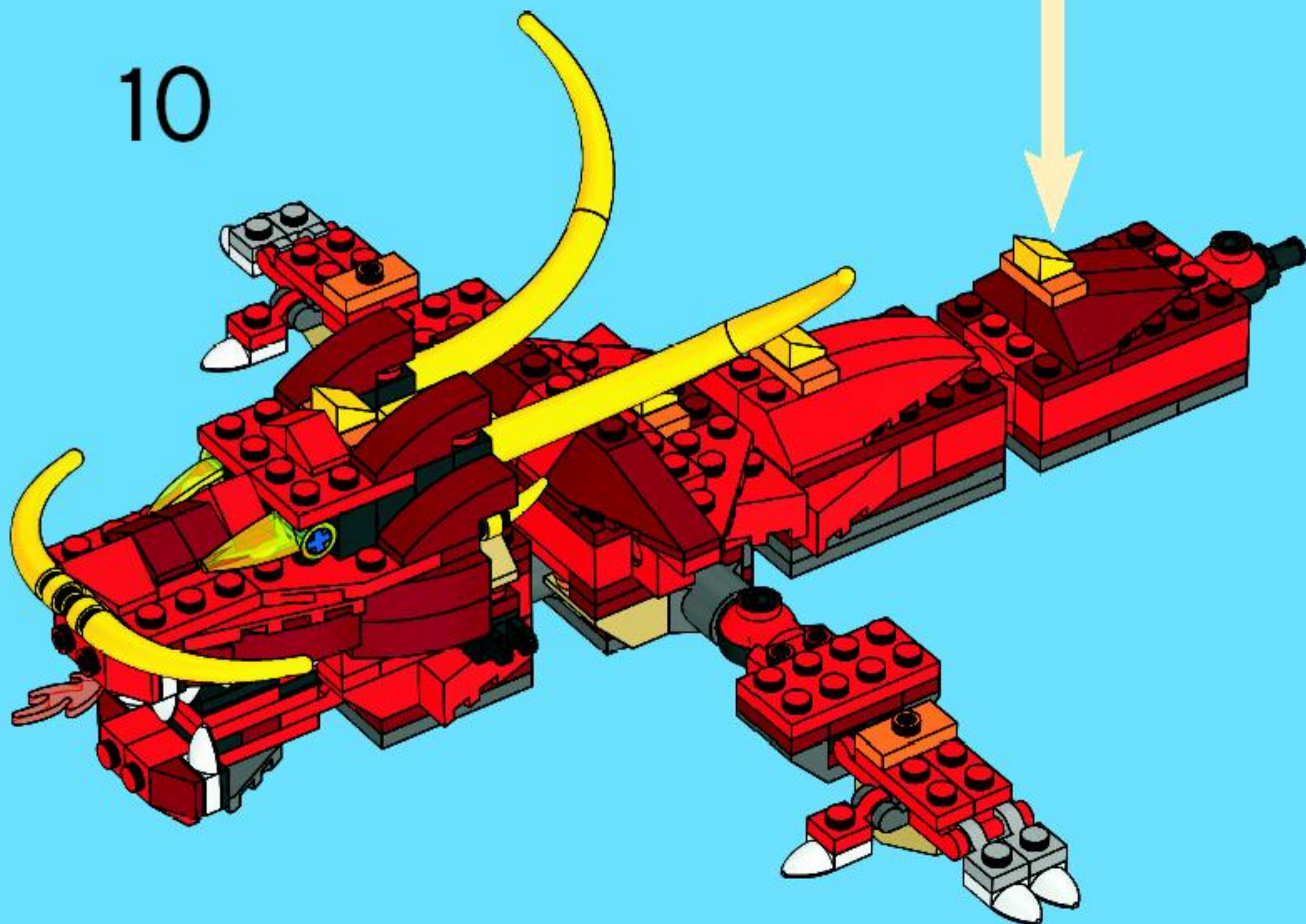



2x

1

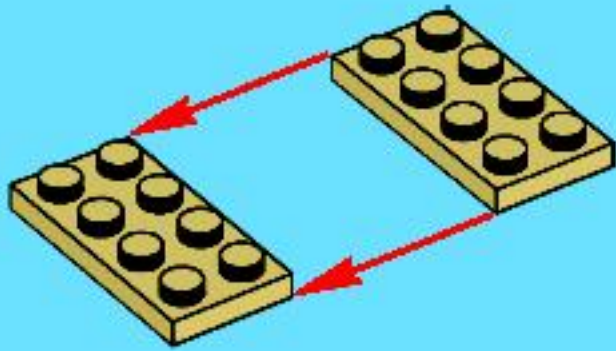

2x



1x

2



2x



4x

3

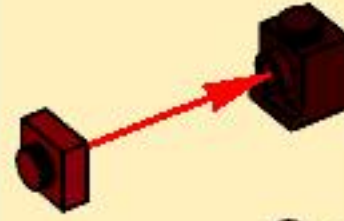

2x

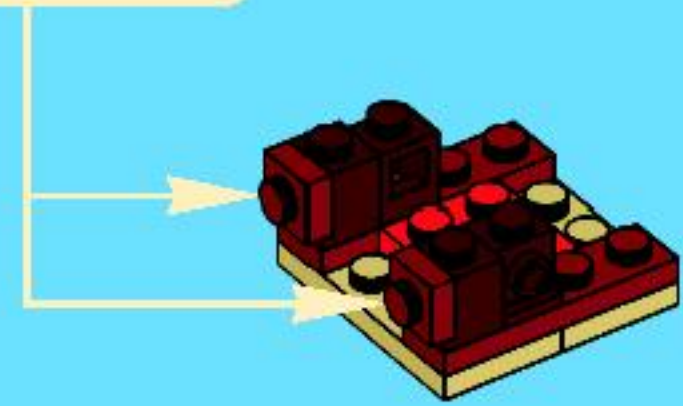

2x



1x

4

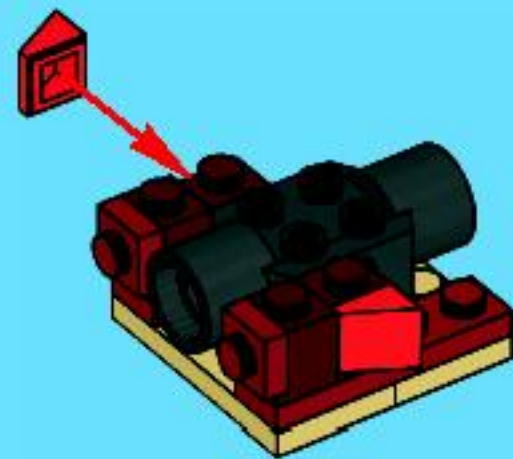



2x

5

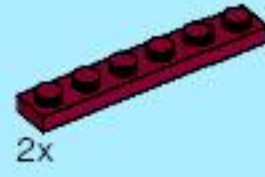
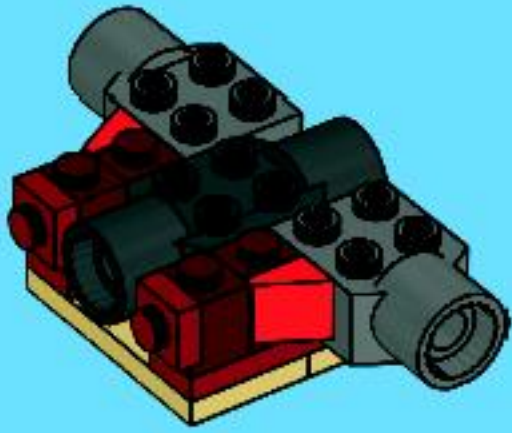

2x



1x

7

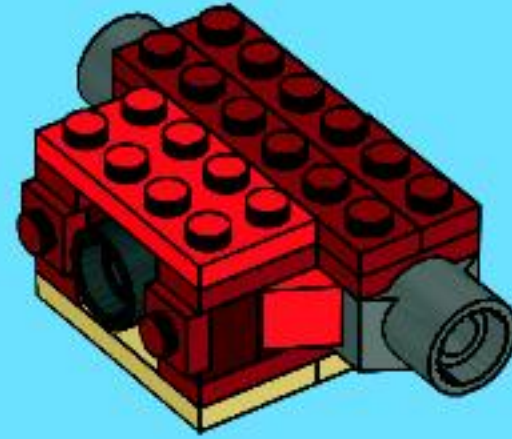

2x



3x



1x

6

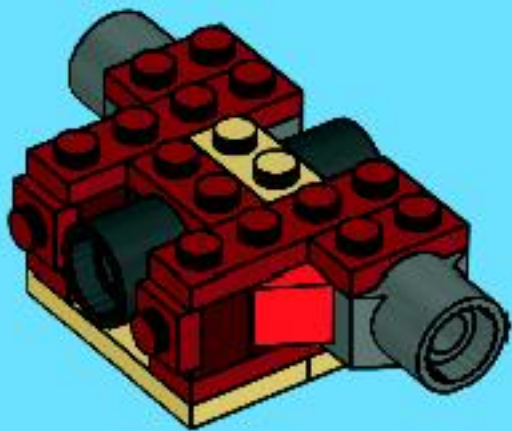

1x

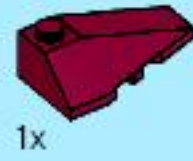

1x

8

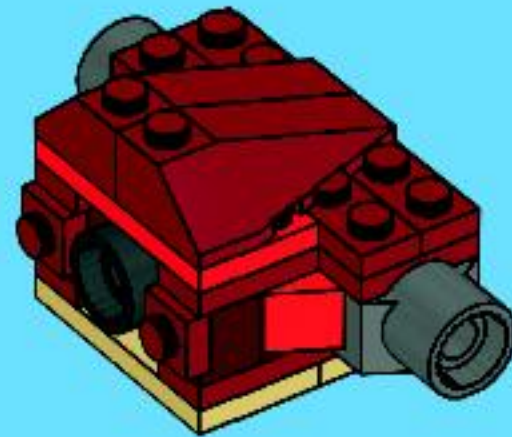



1x



1x

9

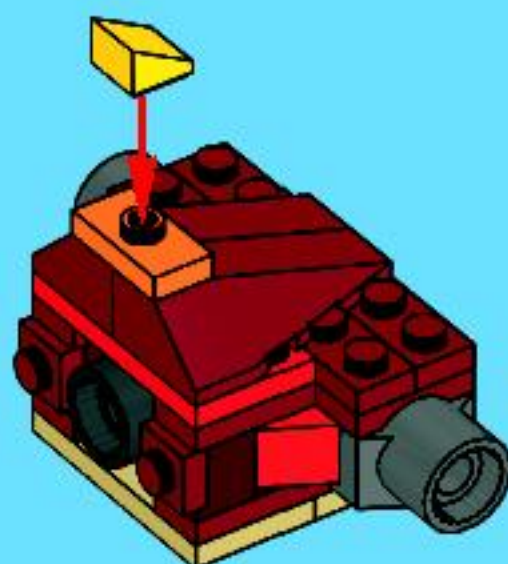

10

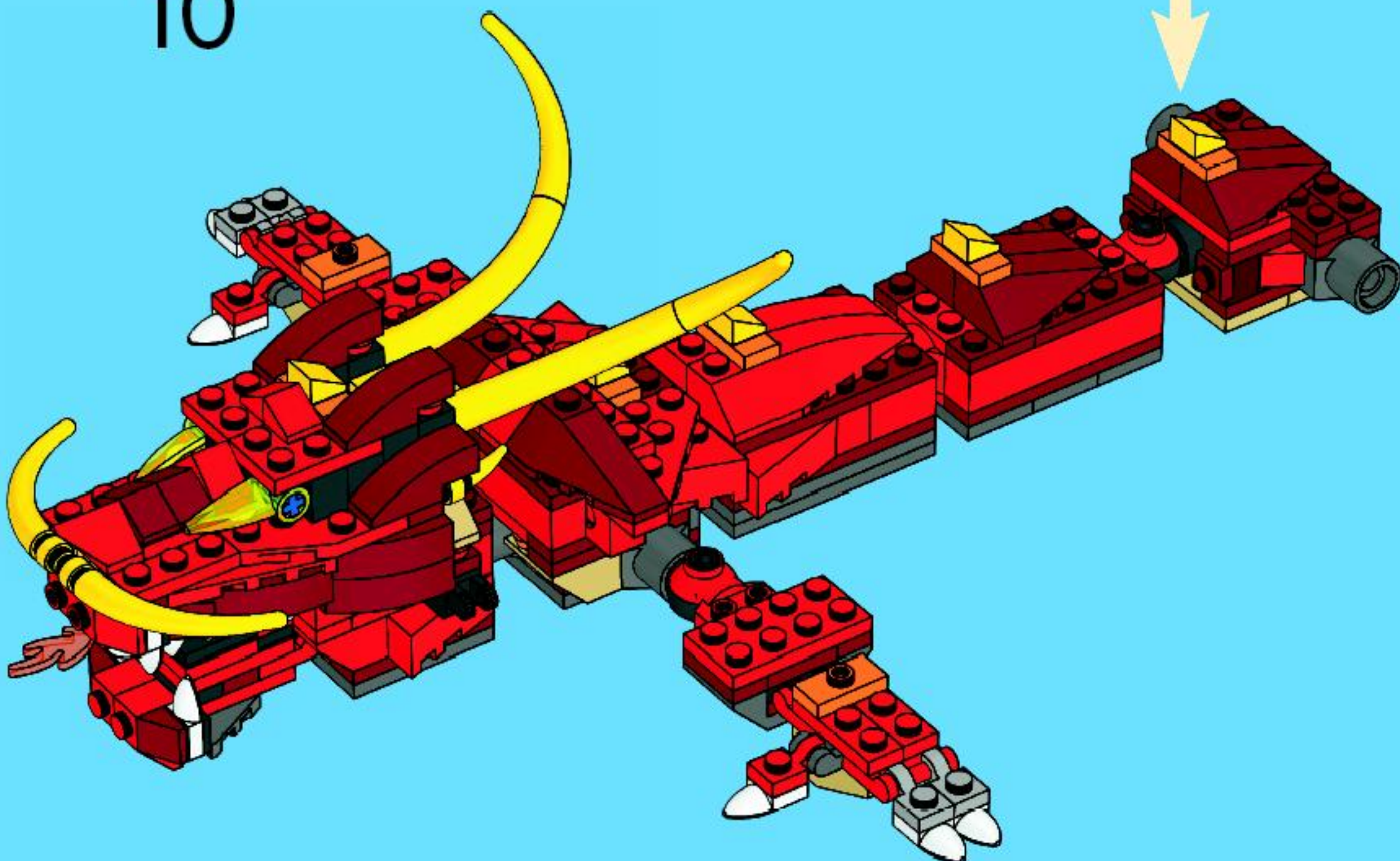

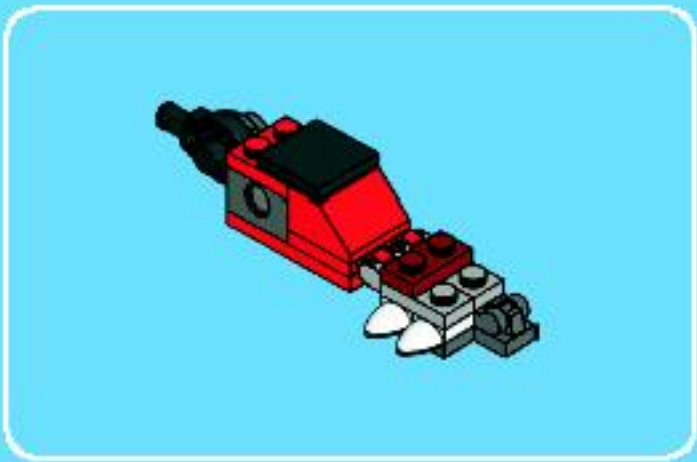

1x

1



1x

2

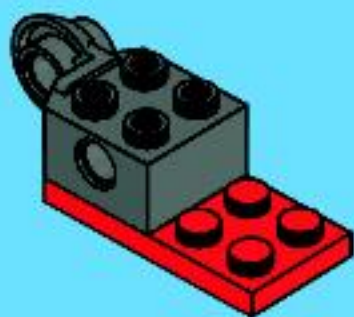

2x



1x

3

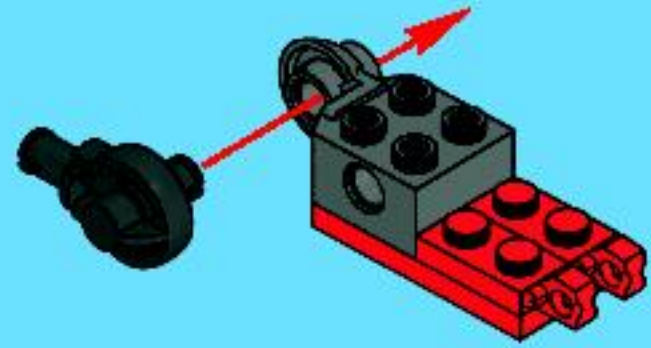

1x



1x

4

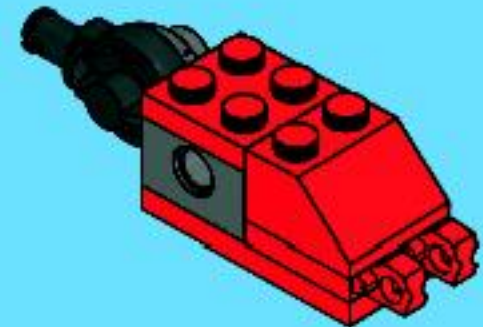

1x

5





1x



2x



2x



1x



1x



1x

6

1



3



2



4

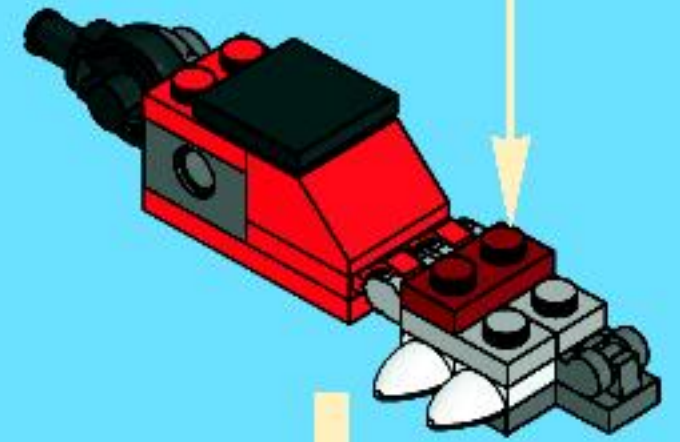
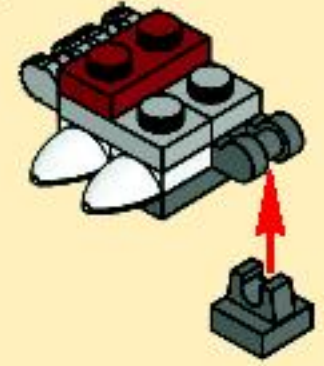

7

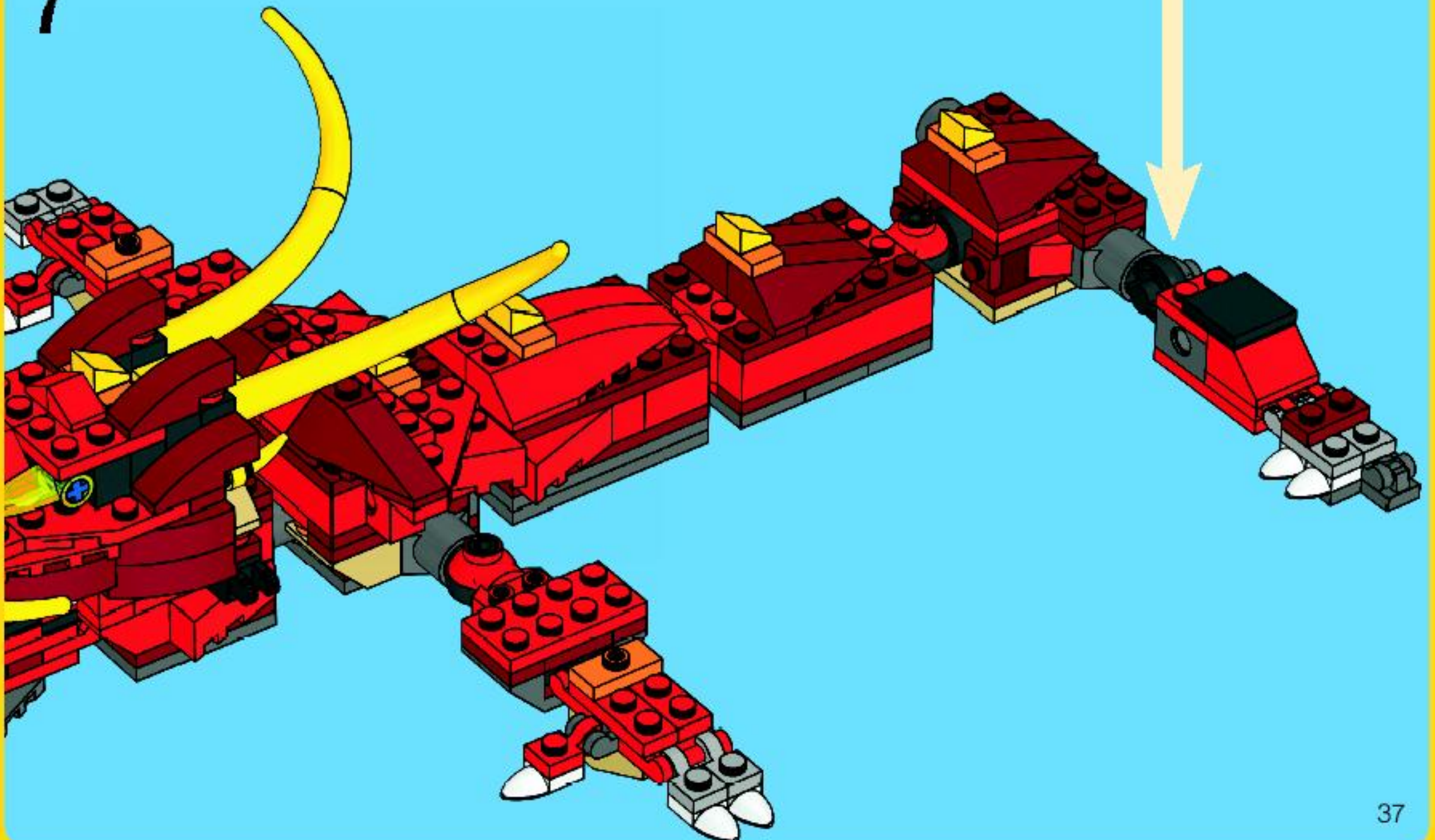

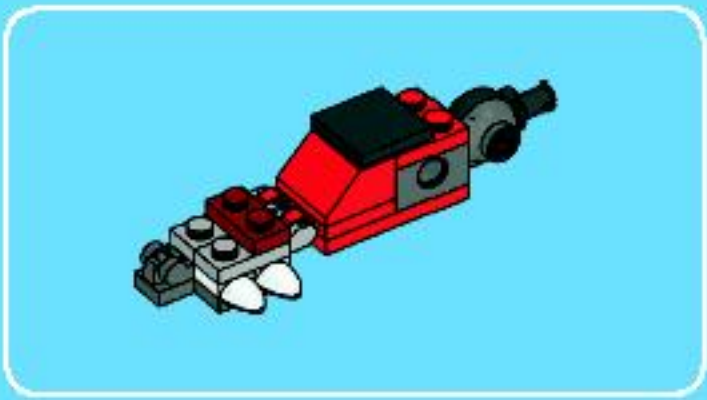

1



2

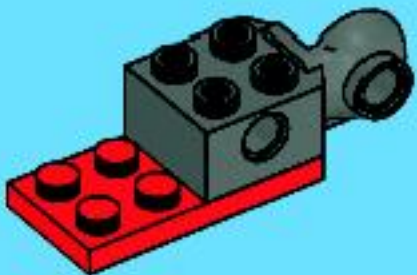

3

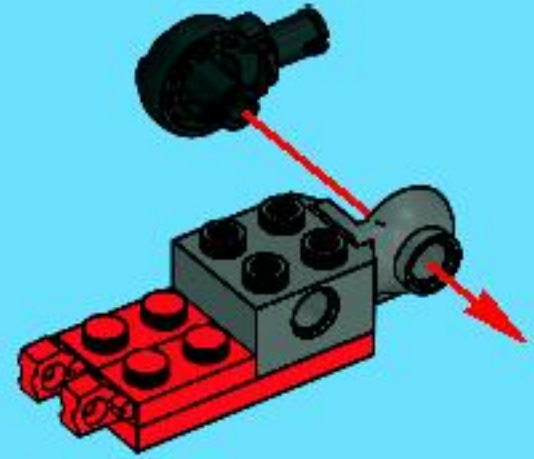

4

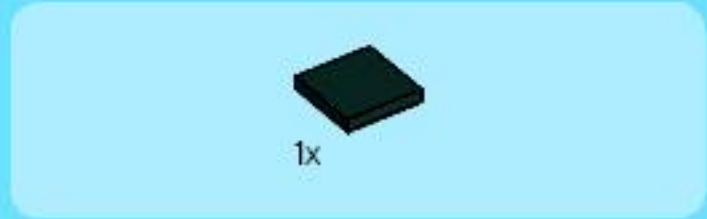
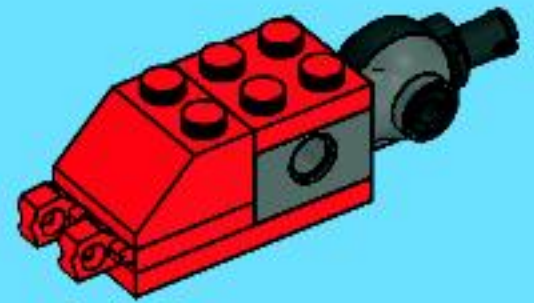

5

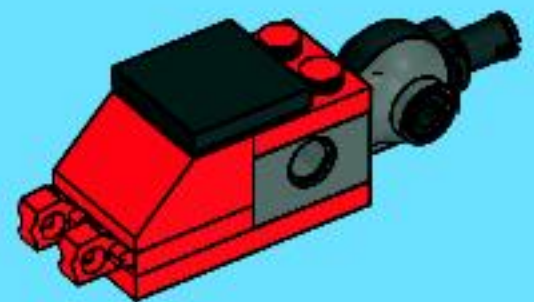

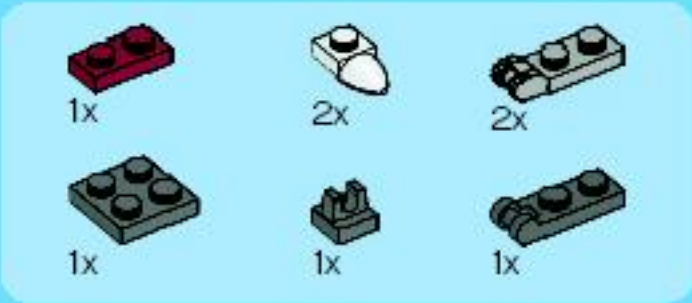

6

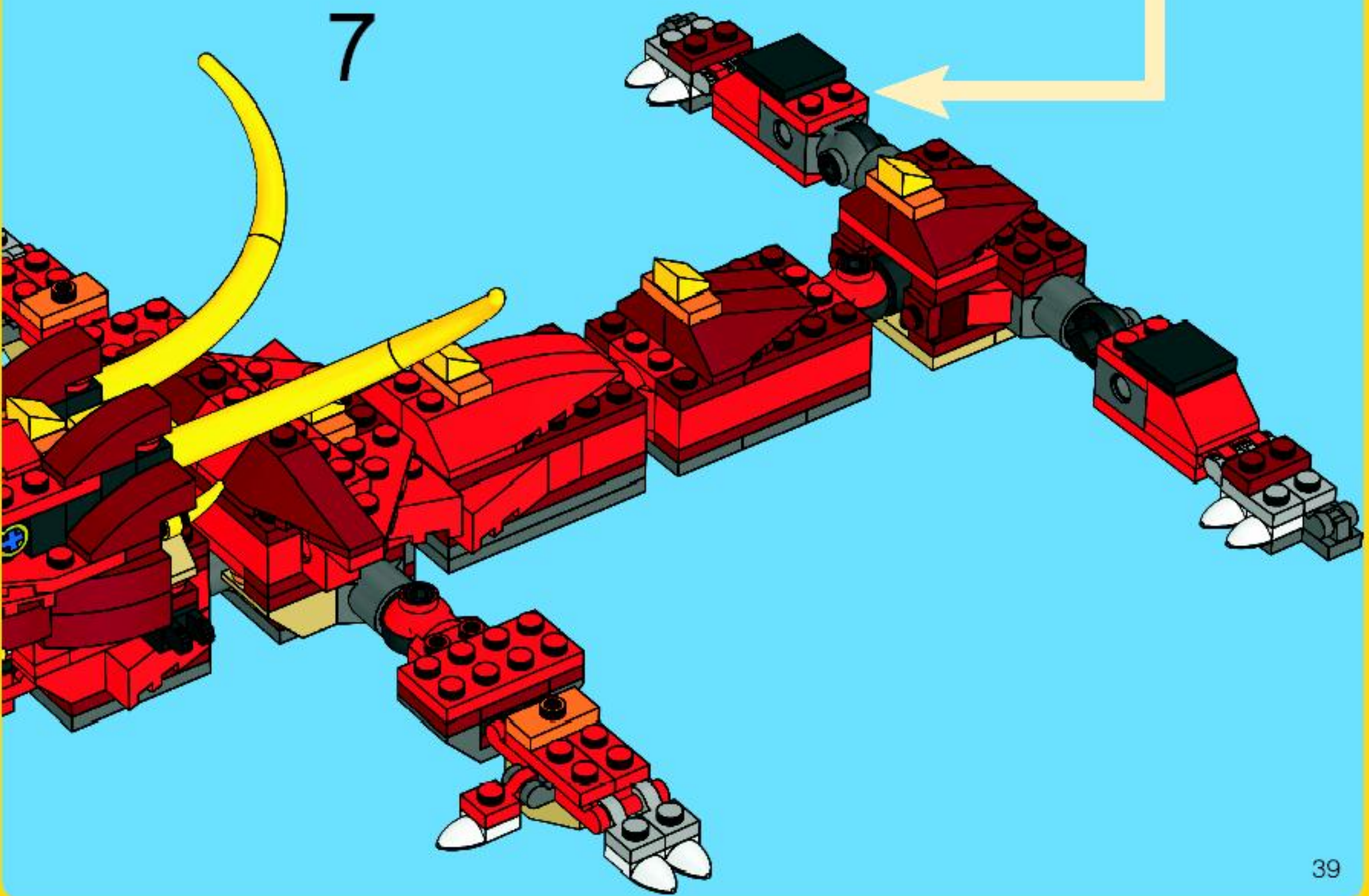
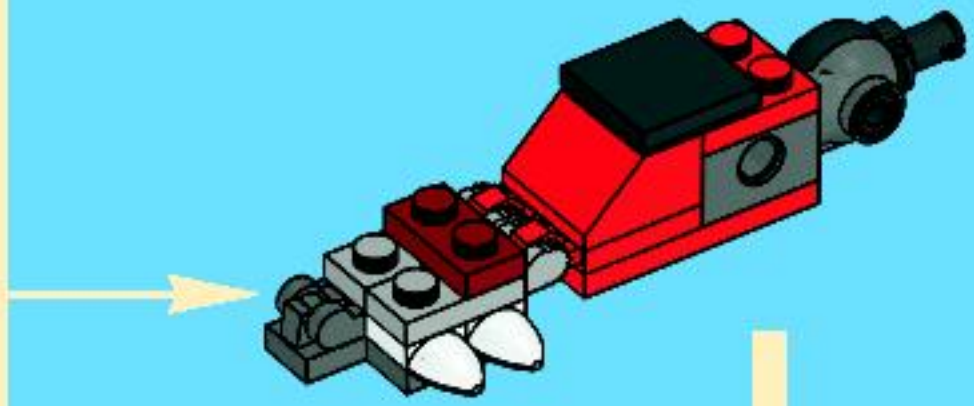
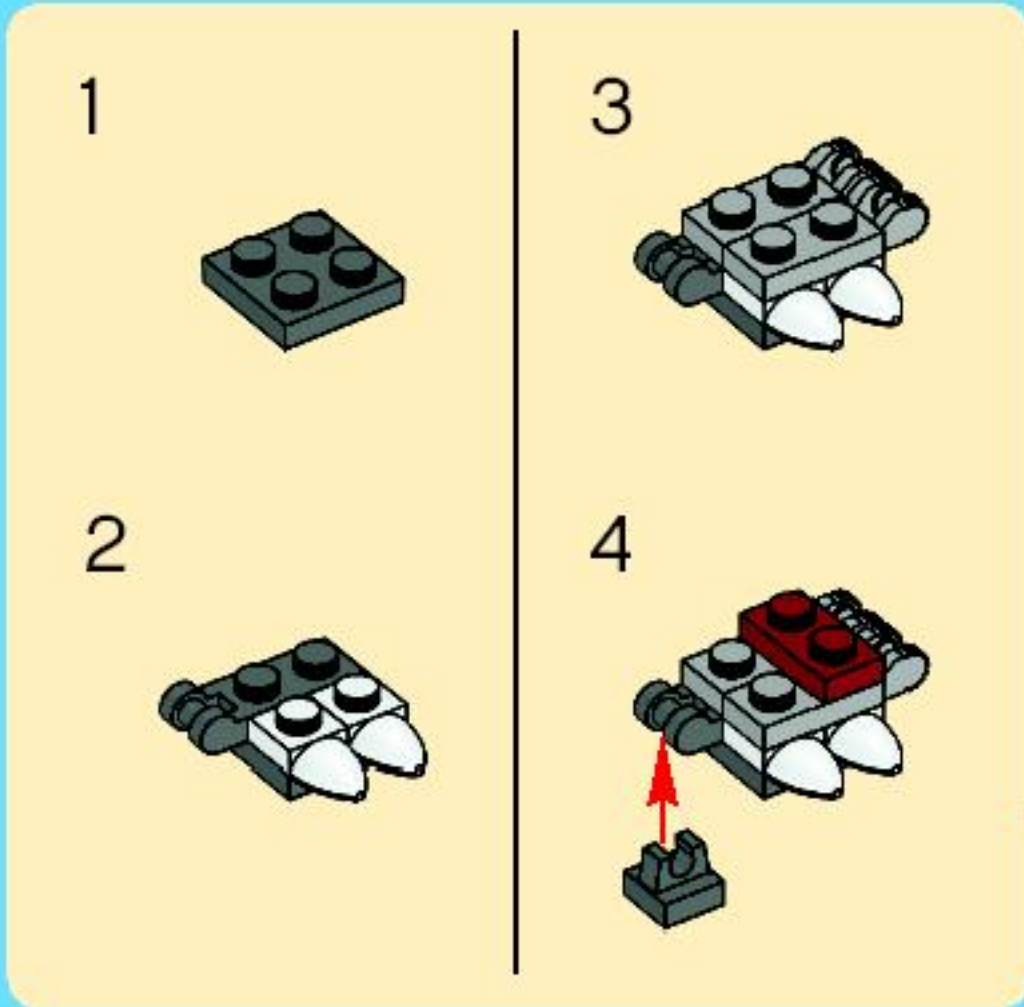

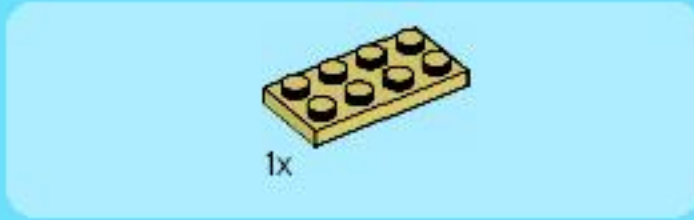
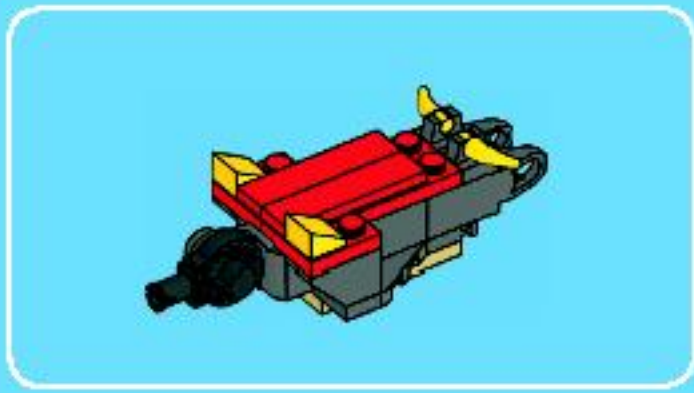

1

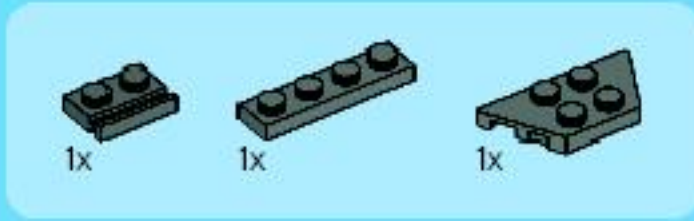

2

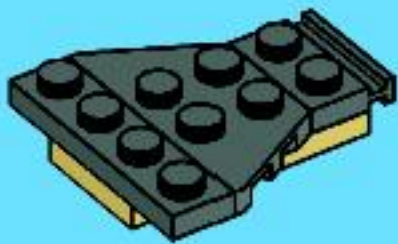

3

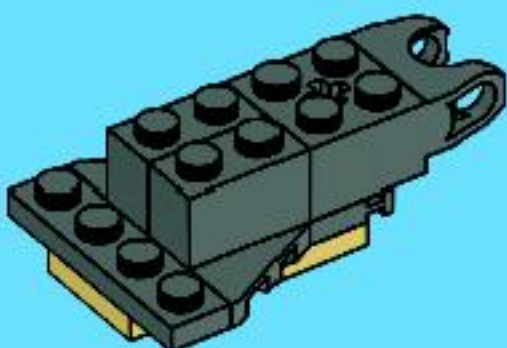

4

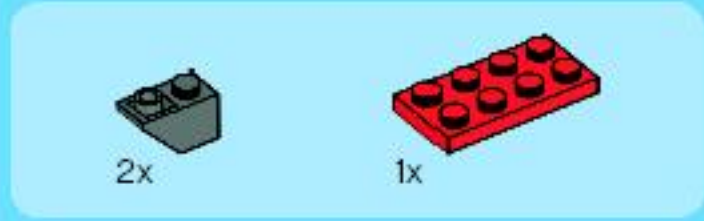
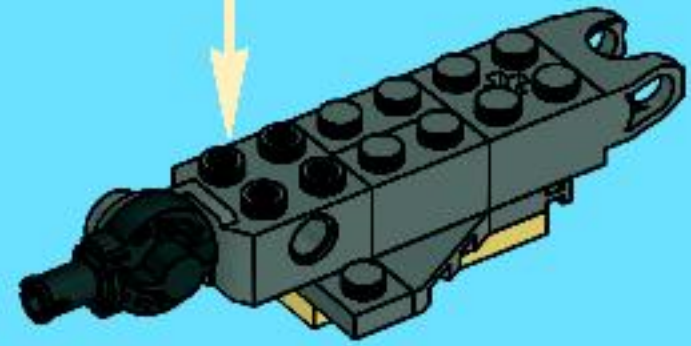
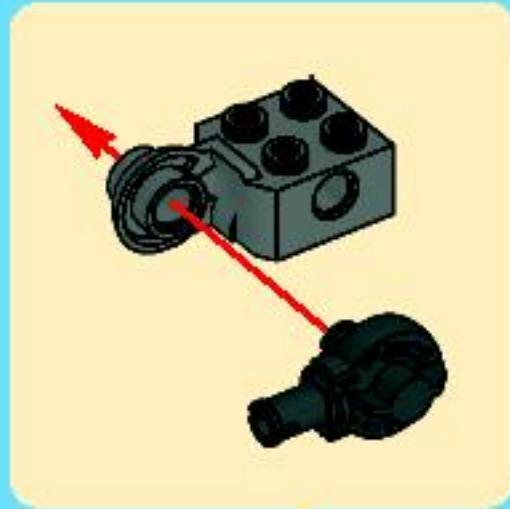

5

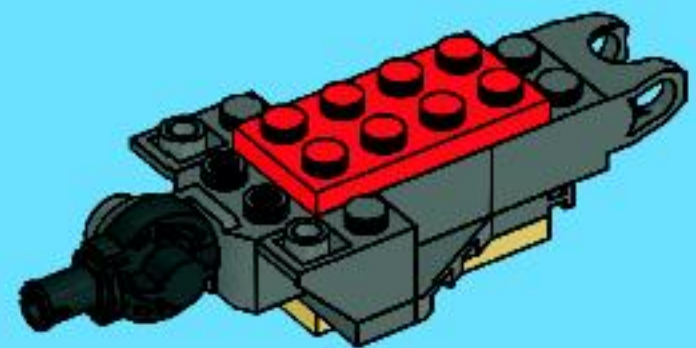

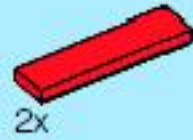

6

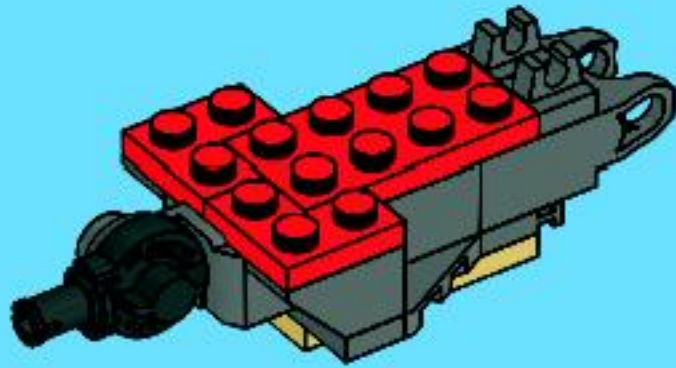

7

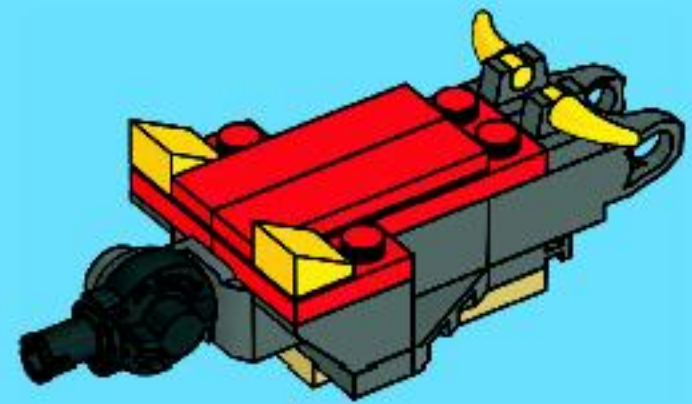

8

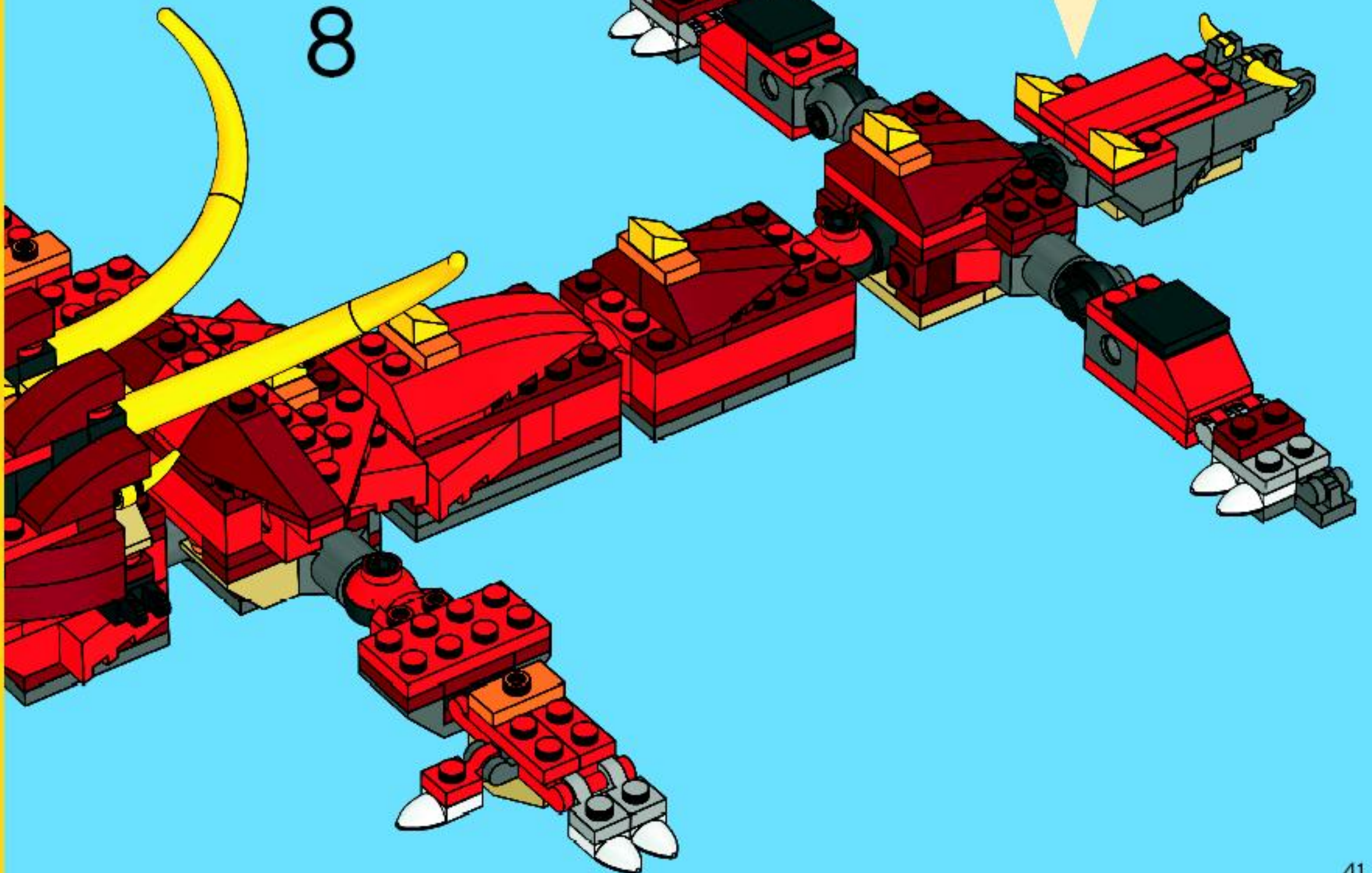

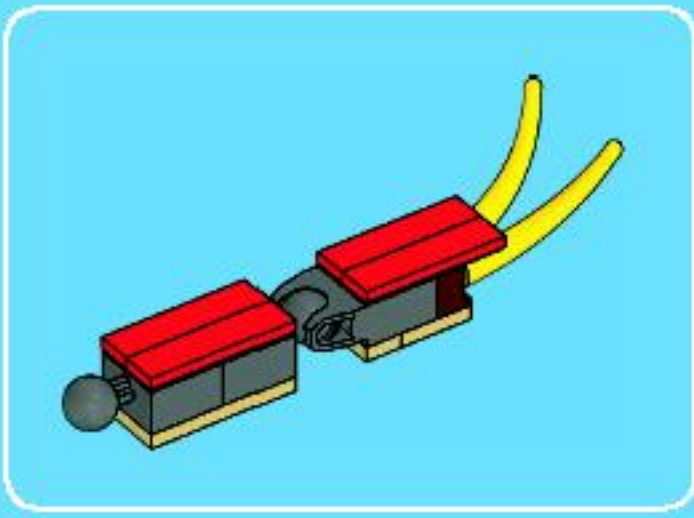

1

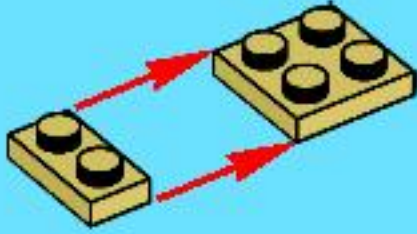

2

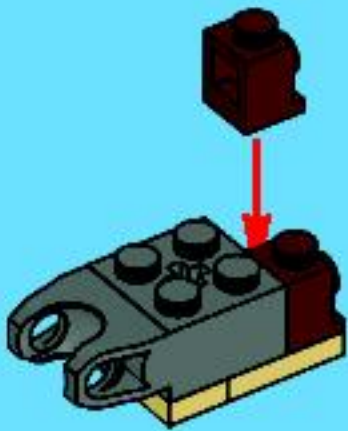

3

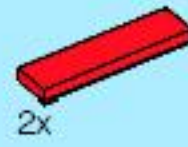
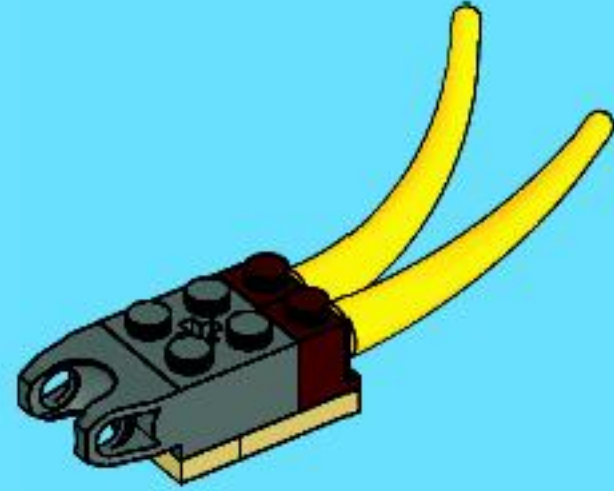

4

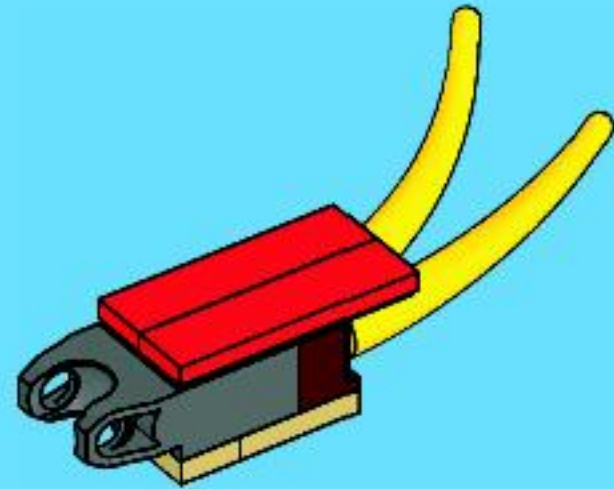



1x



2x



2x

5

1

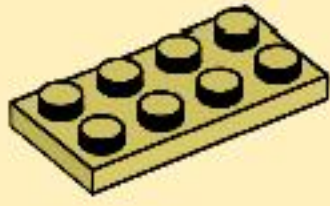

2

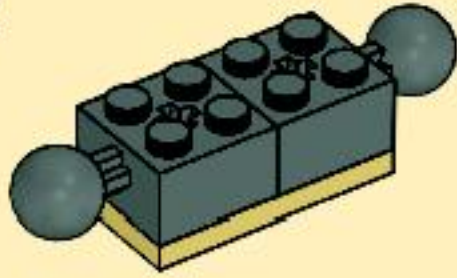

3

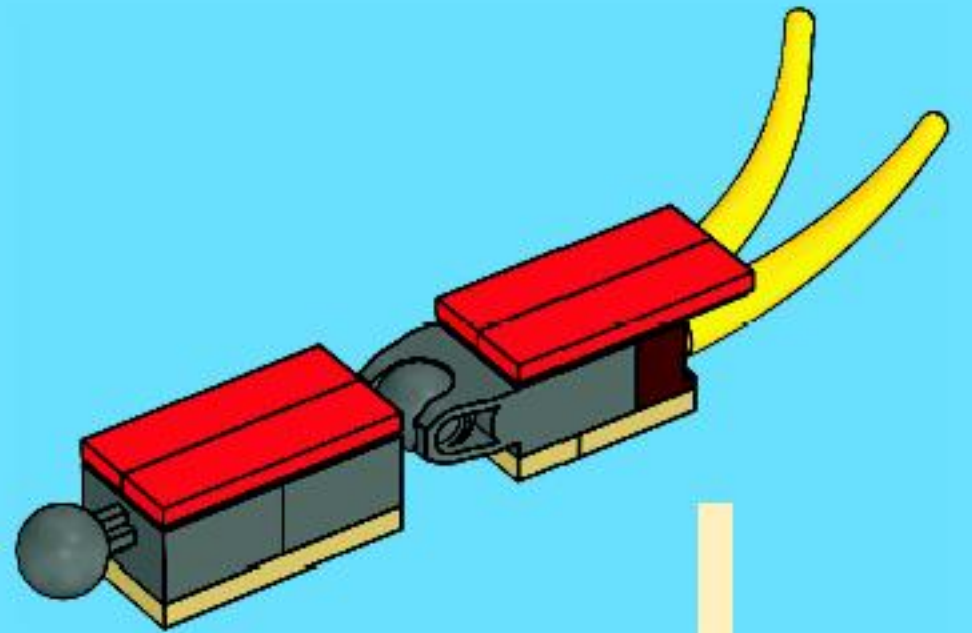
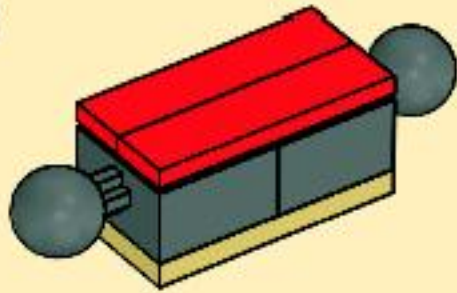

6





6751



6752



6754



6753



6741



6745



6747



6742



6743



CREATOR





CREATOR



3 IN 1

Lade dein eigenes Modell hoch

Bei LEGO Creator findest du in jeder Set-Anleitung ein direktes Tutorial zum Nachbauen deines Modells und sogar ein kleines Forum in der Online-Creator-Galerie.
Auf der LEGO Creator Seite findest du alle Modelle und viele tolle Downloads.
Du kannst sogar einem Designer Fragen stellen und lassen, was unsere Designer schon alles in der Creator-Mag-Galerie haben. Gehe einfach unter www.LEGO.com/Creator.

Télécharge ton propre modèle

Chaque boîte LEGO Creator contient des instructions de montage pour construire 3 modèles particuliers ! Tu as construit un super modèle que tu voudrais montrer ? Télécharge et expose ta propre construction dans la galerie en ligne de site Creator. Tu vas découvrir tous les modèles Creator et les super fans d'écran à télécharger sur le site www.LEGO.com/Creator. Tu peux même poser des questions aux concepteurs et surfer sur le blog Creator.

Envía tu propio modelo

LEGO Creator contiene instrucciones para 3 fantásticos modelos en cada caja. ¿Qué quieres crear? Crea tus propios modelos y súbelos a la galería en línea de Creator. Ven a ver todos los modelos y descargas Creator en nuestro sitio web. También podrás hacer preguntas a un diseñador e investigar las últimas novedades en el blog de Creator. Compruébalo en www.LEGO.com/Creator.

Faz o upload do teu modelo

LEGO Creator dá-te instrucións para 3 fabulosos modelos en cada caixa. O que podes crear? Constrúe o teu propio modelo e fá o upload do mesmo para a galería online Creator. Consulta todos os modelos Creator e posibilidades de download no noso super-fantástico site. Tamén podes colocar nos cuestións a un diseñador e descubrir o que se pasa no blog Creator. Vai á www.LEGO.com/Creator.

Tedd fel a netur sajtómodelljeidet

Minden létező LEGO Creator-ban 3 remek modell készíthető. Szeretnéd megmutatni mindenkinek? Töltsd fel a Creator galériába. Itt megismerheted mindenki alkotásait és érdekes, legújabb híreket is láthatsz.
Nézz körül talázz fel és elemezzed a Creator blogban a legújabb híreket.
Hírd meg másokról is: www.LEGO.com/Creator.

Upload your own model

LEGO Creator gives you instructions for 3 great models in every box! What can you create? Make your own model and upload it to the online Creator gallery. Check out all of the Creator models and downloads on our cool site. You can also ask a designer a question and find out what's going on in the Creator blog. Check it out at www.LEGO.com/Creator.

www.LEGO.com/Creator

